

# INSPIRATION CONTEMPORARY



This section of our brochure contains an exceptional selection of contemporary and traditional products, all crafted with high-quality materials using a proven manufacturing process. With their intricate details, distinctive finishes and original designs, they can easily be coordinated with a wide variety of styles.





REF. NO.	COLOR FINISH	MATERIAL DESCRIPTION	DIMENSION C.C. / Ø	OVERALL DIMENSION (L x P) METRIC	OVERALL DIMENSION (L x P) IMPERIAL	SCREW NAIL
1	6216 140, 140/90	Metal	16mm c.c.	50 x 20mm	1 31/32" x 25/32"	M4
2	32224 140/90	Metal	224mm c.c.	240 x 30mm	9 7/16" x 1 3/16"	M4
3	480544 140	Metal	544mm c.c.	700 x 33mm	27 9/16" x 1 1/4"	M4
	480448 140	Metal	448mm c.c.	500 x 33mm	19 11/16" x 1 1/4"	M4
	480320 140	Metal	320mm c.c.	360 x 33mm	14 3/16" x 1 1/4"	M4
	480224 140	Metal	224mm c.c.	260 x 33mm	10 1/4" x 1 1/4"	M4
4	480038 140	Metal		38 x 33mm	1 1/2" x 1 1/4"	M4
5	167288 140	Metal	288mm c.c.	304 x 20mm	12" x 25/32"	M4
6	167128 140	Metal	128mm c.c.	140 x 20mm	5 1/2" x 25/32"	M4

REF. NO.	COLOR FINISH	MATERIAL DESCRIPTION	DIMENSION C.C. / Ø	OVERALL DIMENSION (L x P) METRIC	OVERALL DIMENSION (L x P) IMPERIAL	SCREW NAIL
7	7794320 90/140	Aluminium & Metal	320mm c.c.	327 x 30mm	12 7/8" x 1 3/16"	M4
	7794160 90/140	Aluminium & Metal	160mm c.c.	167 x 30mm	6 9/16" x 1 3/16"	M4
	7794128 90/140	Aluminium & Metal	128mm c.c.	135 x 30mm	5 5/16" x 1 3/16"	M4
	779496 90/140	Aluminium & Metal	96mm c.c.	103 x 30mm	4 1 1/16" x 1 3/16"	M4
8	779432 90/140	Aluminium & Metal	32mm c.c.	39 x 30mm	1 1/2" x 1 3/16"	M4
9	10056416 140	Metal	416mm c.c.	438 x 26mm	17 1/4" x 1 1/32"	M4
10	10056160 140	Metal	160mm c.c.	181 x 25mm	7 1/8" x 1"	M4
11	579160 140/ 30, 90	Duron® & Metal	160mm c.c.	245 x 28mm	9 5/8" x 1 3/32"	M4
12	217217 140/ 30, 90	Duron® & Metal	Ø 24mm	24 x 23mm	15/16" x 29/32"	M4
13	57360 140/ 30, 90	Metal & Leather	16mm c.c.	60 x 24mm	2 3/8" x 15/16"	M4
14	7830192 140, 091	Metal	192mm c.c.	206 x 28mm	8 1/8" x 1 1/8"	M4





REF. NO.	COLOR FINISH	MATERIAL DESCRIPTION	DIMENSION C.C. / Ø	OVERALL DIMENSION (L x P)		SCREW NAIL
				METRIC	IMPERIAL	
1	174	Metal	64mm c.c.	133 x 16mm	5 1/4" x 5/8"	M4
2	174	Metal		32 x 16mm	1 1/4" x 5/8"	M4
3	174	Metal	32mm c.c.	92 x 16mm	3 5/8" x 5/8"	M4
4	174	Metal	192mm c.c.	245 x 26mm	9 21/32" x 1 1/32"	M4
5	174	Metal	160mm c.c.	228 x 26mm	8 31/32" x 1 1/32"	M4
6	174	Metal	128mm c.c.	168 x 26mm	6 5/8" x 1 1/32"	M4
7	174	Metal	224mm c.c.	236 x 39mm	9 9/32" x 1 17/32"	M4
8	174	Metal	160mm c.c.	172 x 39mm	6 25/32" x 1 17/32"	M4

REF. NO.	COLOR FINISH	MATERIAL DESCRIPTION	DIMENSION C.C. / Ø	OVERALL DIMENSION (L x P)		SCREW NAIL
				METRIC	IMPERIAL	
9	174	Metal	96mm c.c.	108 x 39mm	4 1/4" x 1 17/32"	M4
10	174	Metal	128mm c.c.	143 x 32mm	5 5/8" x 1 1/4"	M4
11	174	Metal	64mm c.c.	80 x 32mm	3 5/32" x 1 1/4"	M4
12	174	Metal	32mm c.c.	48 x 32mm	1 7/8" x 1 1/4"	M4
13	175	Metal	96mm c.c.	143 x 22mm	5 5/8" x 7/8"	M4
14	175	Metal	32mm c.c.	46 x 18mm	1 13/16" x 23/32"	M4
15	174	Metal	43 x 22mm		1 11/16" x 7/8"	M4
16	174	Metal	16mm c.c.	60 x 30mm	2 3/8" x 1 3/16"	M4



design PHILIPPE STARK

REF. NO.	COLOR FINISH	MATERIAL DESCRIPTION	DIMENSION C.C. / Ø	OVERALL DIMENSION (L x P) METRIC	OVERALL DIMENSION (L x P) IMPERIAL	SCREW NAIL
1	21683160	140 Metal	160mm c.c.	174 x 35mm	6 27/32" x 1 3/8"	M4
2	21683192	140 Metal	192mm c.c.	205 x 35mm	8 1/16" x 1 3/8"	M4
3	21724352	140, 174 Metal	352mm c.c.	362 x 34mm	14 1/4" x 1 11/32"	M4
4	21724288	140, 174 Metal	288mm c.c.	297 x 34mm	11 11/16" x 1 11/32"	M4
5	21724224	140, 174 Metal	224mm c.c.	235 x 34mm	9 1/4" x 1 11/32"	M4
6	211192	174 Metal	192mm c.c.	230 x 34mm	9 1/16" x 1 11/32"	M4

REF. NO.	COLOR FINISH	MATERIAL DESCRIPTION	DIMENSION C.C. / Ø	OVERALL DIMENSION (L x P) METRIC	OVERALL DIMENSION (L x P) IMPERIAL	SCREW NAIL
7	311128	185 Metal	128mm c.c.	146 x 29mm	5 3/4" x 1 5/32"	M4
8	311448	185 Metal	448mm c.c.	524 x 28mm	20 5/8" x 1 3/32"	M4
9	883192	174 Metal	192mm c.c.	243 x 35mm	9 9/16" x 1 3/8"	M4
10	883128	174 Metal	128mm c.c.	167 x 35mm	6 9/16" x 1 3/8"	M4
11	16307	174 Metal	16mm c.c.	66 x 28mm	2 19/32" x 1 3/32"	M4
12	216406	145 Metal		45 x 25mm	1 25/32" x 1"	M4





1

195

905

140

2

3

5

4

6

7

REF. NO.	COLOR FINISH	MATERIAL DESCRIPTION	DIMENSION C.C. / Ø	OVERALL DIMENSION (L x P)		SCREW NAIL
				METRIC	IMPERIAL	
1	5187320 140, 195, 905	Metal	320mm c.c.	342 x 34mm	13 7/16" x 1 5/16"	M4
2	5187192 140, 195, 905	Metal	192mm c.c.	214 x 32mm	8 7/16" x 1 1/4"	M4
3	5187128 140, 195, 905	Metal	128mm c.c.	150 x 31mm	5 7/8" x 1 3/16"	M4
4	5187043 140, 195, 905	Metal		43 x 31mm	1 11/16" x 1 3/16"	M4

REF. NO.	COLOR FINISH	MATERIAL DESCRIPTION	DIMENSION C.C. / Ø	OVERALL DIMENSION (L x P)		SCREW NAIL
				METRIC	IMPERIAL	
5	5182160 140, 195, 905	Metal	160mm c.c.	250 x 19mm	9 13/16" x 3/4"	M4
6	5182096 140, 195, 905	Metal	96mm c.c.	170 x 19mm	6 11/16" x 3/4"	M4
7	5182064 140, 195, 905	Metal	64mm c.c.	110 x 19mm	4 5/16" x 3/4"	M4



REF. NO.	COLOR FINISH	MATERIAL DESCRIPTION	DIMENSION C.C. / Ø	OVERALL DIMENSION (L x P) METRIC	OVERALL DIMENSION (L x P) IMPERIAL	SCREW NAIL
1	5183224	140, 195, 905 Metal	224mm c.c.	281 x 35mm	11 1/16" x 1 3/8"	M4
2	5183128	140, 195, 905 Metal	128mm c.c.	185 x 35mm	7 1/4" x 1 3/8"	M4
3	5183020	140, 195, 905 Metal	Ø 20mm	20 x 35mm	3/4" x 1 3/8"	M4

REF. NO.	COLOR FINISH	MATERIAL DESCRIPTION	DIMENSION C.C. / Ø	OVERALL DIMENSION (L x P) METRIC	OVERALL DIMENSION (L x P) IMPERIAL	SCREW NAIL
4	5180096	140, 195, 905 Metal	96mm c.c.	280 x 19mm	11" x 3/4"	M4
5	5180064	140, 195, 905 Metal	64mm c.c.	210 x 19mm	8 1/4" x 3/4"	M4
6	5180032	140, 195, 905 Metal	32mm c.c.	130 x 19mm	5 1/8" x 3/4"	M4

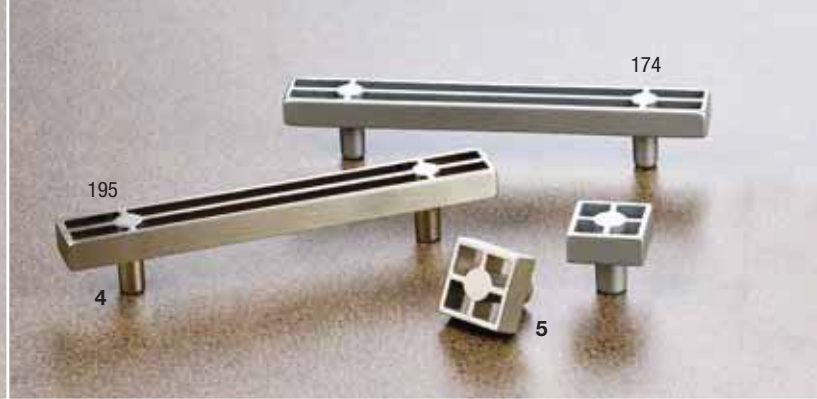

REF. NO.	COLOR FINISH	MATERIAL DESCRIPTION	DIMENSION C.C. / Ø	OVERALL DIMENSION (L x P) METRIC	OVERALL DIMENSION (L x P) IMPERIAL	SCREW NAIL
1	900	Metal	128mm c.c.	140 x 29mm	5 1/2" x 1 5/32"	M4
2	195	Metal	16mm c.c.	128 x 24mm	5 1/32" x 15/16"	M4
3	195	Metal	Ø 30mm	30 x 24mm	1 3/16" x 15/16"	M4
4	174, 195	Metal	96mm c.c.	138 x 24mm	5 7/16" x 15/16"	M4
5	174, 195	Metal	24 x 24mm	24 x 24mm	15/16" x 15/16"	M4
6	195	Metal	128mm c.c.	152 x 32mm	5 31/32" x 1 1/4"	M4
7	195	Metal	96mm c.c.	120 x 32mm	4 5/8" x 1 1/4"	M4
8	195	Metal	96mm c.c.	126 x 29mm	4 31/32" x 1 5/32"	M4
9	140, 160, 185	Brass	96mm c.c.	147 x 28mm	5 25/32" x 1 3/32"	M4

REF. NO.	COLOR FINISH	MATERIAL DESCRIPTION	DIMENSION C.C. / Ø	OVERALL DIMENSION (L x P) METRIC	OVERALL DIMENSION (L x P) IMPERIAL	SCREW NAIL
10	195	Metal	128mm c.c.	145 x 35mm	5 23/32" x 1 3/8"	M4
11	195	Metal	96mm c.c.	110 x 35mm	4 11/32" x 1 3/8"	M4
12	184	Metal	96mm c.c.	110 x 28mm	4 11/32" x 1 3/32"	M4
13	140, 185	Brass	Ø 30mm	30 x 28mm	1 3/16" x 1 3/32"	M4
14	185	Brass	Ø 25mm	25 x 25mm	1" x 1"	M4
15	140, 185	Brass	Ø 35mm	35 x 30mm	1 3/8" x 1 3/16"	M4
16	140, 185	Brass	25 x 35mm	25 x 35mm	1" x 1 3/8"	M4
17	140, 185	Brass	20 x 30mm	20 x 30mm	25/32" x 1 3/16"	M4





REF. NO.	COLOR FINISH	MATERIAL DESCRIPTION	DIMENSION C.C. / Ø	OVERALL DIMENSION (L x P) METRIC	OVERALL DIMENSION (L x P) IMPERIAL	SCREW NAIL
1	77150224	195 Metal	224mm c.c.	235 x 54mm	9 1/4" x 2 1/8"	M4
2	7791192	195 Metal	192mm c.c.	334 x 30mm	13 1/8" x 1 3/16"	M4
3	7791128	195 Metal	128mm c.c.	240 x 26mm	9 7/16" x 1"	M4
4	6161051032	195 Metal	32mm c.c.	80 x 31mm	3 5/32" x 1 7/32"	M4
5	616435100	195 Metal	Ø 100mm	100 x 34mm	3 15/16" x 1 11/32"	M4
6	61643450	195 Metal	Ø 50mm	50 x 33mm	1 31/32" x 1 5/16"	M4
7	21690160	140 Metal	160mm c.c.	185 x 35mm	7 9/32" x 1 3/8"	M4
8	21690128	140 Metal	128mm c.c.	150 x 35mm	5 29/32" x 1 3/8"	M4
9	21723128	140 Metal	128mm c.c.	138 x 27mm	5 7/16" x 1 1/16"	M4

REF. NO.	COLOR FINISH	MATERIAL DESCRIPTION	DIMENSION C.C. / Ø	OVERALL DIMENSION (L x P) METRIC	OVERALL DIMENSION (L x P) IMPERIAL	SCREW NAIL
10	356011	140 Metal	Ø 30mm	30 x 26mm	1 3/16" x 1 1/32"	8/32
11	2171619	140 Metal	Ø 19mm	19 x 23mm	3/4" x 29/32"	M4
12	745236128	195 Metal	128mm c.c.	140 x 30mm	5 1/2" x 1 3/16"	M4
13	74523732	195 Metal	32mm c.c.	44 x 30mm	1 23/32" x 1 3/16"	M4
14	745242160	195 Metal	160mm c.c.	178 x 25mm	7" x 1"	M4
15	21693160	140, 174 Metal	160mm c.c.	170 x 26mm	6 11/16" x 1 1/32"	M4
16	745238192	195 Metal	192mm c.c.	250 x 25mm	9 27/32" x 1"	M4
17	745239128	195 Metal	128mm c.c.	183 x 25mm	7 7/32" x 1"	M4
18	61632740	140, 195 Metal	Ø 40mm	40 x 27mm	1 9/16" x 1 1/16"	M4



# STAINLESS STEEL

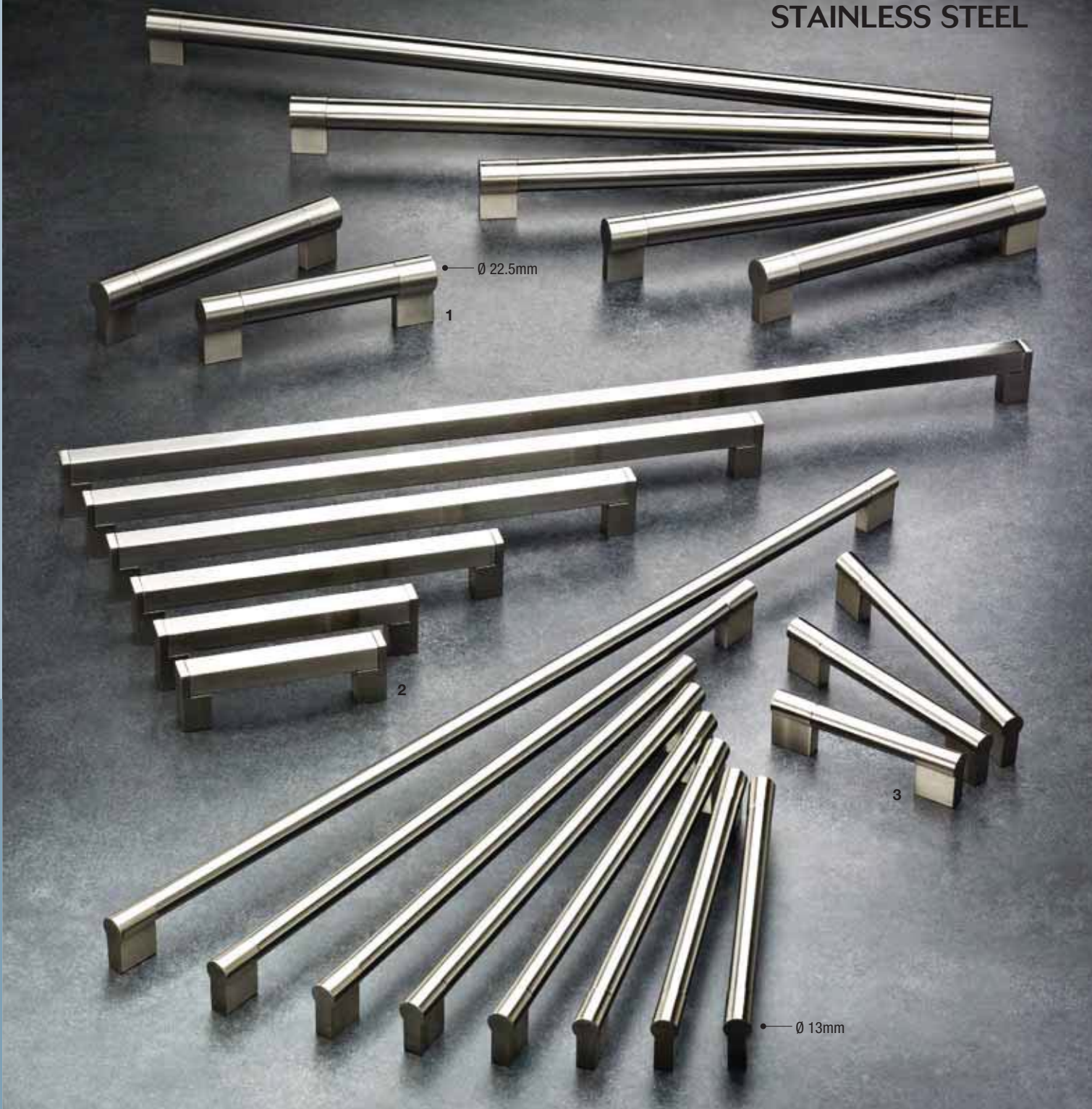

REF. NO.	COLOR FINISH	MATERIAL DESCRIPTION	DIMENSION C.C. / Ø	OVERALL DIMENSION (L x P)		SCREW NAIL	
				METRIC	IMPERIAL		
<b>1</b>	500128	195	Stainless & metal	128mm c.c.	153 x 43mm	6" x 1 11/16"	8/32
	500160	195	Stainless & metal	160mm c.c.	185 x 43mm	7 1/4" x 1 11/16"	8/32
	500192	195	Stainless & metal	192mm c.c.	217 x 43mm	8 1/2" x 1 11/16"	8/32
	500256	195	Stainless & metal	256mm c.c.	281 x 43mm	11 1/16" x 1 11/16"	8/32
	500320	195	Stainless & metal	320mm c.c.	333 x 32mm	13 1/16" x 1 1/4"	8/32
	500448	195	Stainless & metal	448mm c.c.	461 x 32mm	18 1/8" x 1 1/4"	8/32
	500576	195	Stainless & metal	576mm c.c.	589 x 32mm	23 3/16" x 1 1/4"	8/32
<b>2</b>	52096	195	Stainless & metal	96mm c.c.	113 x 38mm	4 7/16" x 1 1/2"	8/32
	520128	195	Stainless & metal	128mm c.c.	145 x 38mm	5 11/16" x 1 1/2"	8/32
	520192	195	Stainless & metal	192mm c.c.	209 x 38mm	8 3/16" x 1 1/2"	8/32
	520288	195	Stainless & metal	288mm c.c.	305 x 38mm	12" x 1 1/2"	8/32
	520384	195	Stainless & metal	384mm c.c.	401 x 38mm	15 3/4" x 1 1/2"	8/32
	520576	195	Stainless & metal	576mm c.c.	593 x 38mm	23 5/16" x 1 1/2"	8/32

REF. NO.	COLOR FINISH	MATERIAL DESCRIPTION	DIMENSION C.C. / Ø	OVERALL DIMENSION (L x P)		SCREW NAIL	
				METRIC	IMPERIAL		
<b>3</b>	52796	195	Stainless & metal	96mm c.c.	109 x 32mm	4 1/4" x 1 1/4"	8/32
	527128	195	Stainless & metal	128mm c.c.	141 x 32mm	5 9/16" x 1 1/4"	8/32
	527160	195	Stainless & metal	160mm c.c.	173 x 32mm	6 13/16" x 1 1/4"	8/32
	527180	195	Stainless & metal	180mm c.c.	193 x 32mm	7 9/16" x 1 1/4"	8/32
	527192	195	Stainless & metal	192mm c.c.	205 x 32mm	8 1/16" x 1 1/4"	8/32
	527224	195	Stainless & metal	224mm c.c.	237 x 32mm	9 5/16" x 1 1/4"	8/32
	527256	195	Stainless & metal	256mm c.c.	269 x 32mm	10 9/16" x 1 1/4"	8/32
	527288	195	Stainless & metal	288mm c.c.	301 x 32mm	11 13/16" x 1 1/4"	8/32
	527320	195	Stainless & metal	320mm c.c.	333 x 32mm	13 1/16" x 1 1/4"	8/32
	527416	195	Stainless & metal	416mm c.c.	429 x 32mm	16 7/8" x 1 1/4"	8/32
	527576	195	Stainless & metal	576mm c.c.	589 x 32mm	23 3/16" x 1 1/4"	8/32

# STAINLESS STEEL



Required clearance for non-contact opening

		Door dimension		
60mm 2 3/8"	40mm 1 9/16"	Handle c.c.	40mm 1 9/16"	60mm 2 3/8"



REF. NO.	COLOR FINISH	MATERIAL DESCRIPTION	DIMENSION C.C. / Ø	DIMENSION DOOR	OVERALL DIMENSION (L x P) METRIC	OVERALL DIMENSION (L x P) IMPERIAL	SCREW NAIL
1 348796	170	Stainless steel	96mm c.c.		176 x 35mm	6 15/16" x 1 3/8"	8/32
3487105	170	Stainless steel	105mm c.c.	12"	185 x 35mm	7 9/32" x 1 3/8"	8/32
3487128	170	Stainless steel	128mm c.c.		208 x 35mm	8 3/16" x 1 3/8"	8/32
3487143	170	Stainless steel	143mm c.c.	13 1/2"	223 x 35mm	8 25/32" x 1 3/8"	8/32
3487181	170	Stainless steel	181mm c.c.	15"	261 x 35mm	10 9/32" x 1 3/8"	8/32
3487219	170	Stainless steel	219mm c.c.	16 1/2"	299 x 35mm	11 25/32" x 1 3/8"	8/32
3487257	170	Stainless steel	257mm c.c.	18"	337 x 35mm	13 9/32" x 1 3/8"	8/32
3487333	170	Stainless steel	333mm c.c.	21"	413 x 35mm	16 1/4" x 1 3/8"	8/32
3487410	170	Stainless steel	410mm c.c.	24"	490 x 35mm	19 9/32" x 1 3/8"	8/32

REF. NO.	COLOR FINISH	MATERIAL DESCRIPTION	DIMENSION C.C. / Ø	DIMENSION DOOR	OVERALL DIMENSION (L x P) METRIC	OVERALL DIMENSION (L x P) IMPERIAL	SCREW NAIL
1 3487486	170	Stainless steel	486mm c.c.	27"	566 x 35mm	22 9/32" x 1 3/8"	8/32
3487562	170	Stainless steel	562mm c.c.	30"	642 x 35mm	25 9/32" x 1 3/8"	8/32
3487638	170	Stainless steel	638mm c.c.	33"	718 x 35mm	28 9/32" x 1 3/8"	8/32
3487714	170	Stainless steel	714mm c.c.	36"	794 x 35mm	31 1/4" x 1 3/8"	8/32
3487790	170	Stainless steel	790mm c.c.	39"	870 x 35mm	34 1/4" x 1 3/8"	8/32
3487867	170	Stainless steel	867mm c.c.	42"	947 x 35mm	37 9/32" x 1 3/8"	8/32
3487943	170	Stainless steel	943mm c.c.	45"	1023 x 35mm	40 9/32" x 1 3/8"	8/32
34871019	170	Stainless steel	1019mm c.c.	48"	1099 x 35mm	43 9/32" x 1 3/8"	8/32
2 348740	170	Stainless steel			40 x 35mm	1 9/16" x 1 3/8"	8/32



# STAINLESS STEEL



REF. NO.	COLOR FINISH	MATERIAL DESCRIPTION	DIMENSION C.C. / Ø	OVERALL DIMENSION (L x P) METRIC	OVERALL DIMENSION (L x P) IMPERIAL	SCREW NAIL
1	2102128	170 Stainless steel	128mm c.c.	185 x 35mm	7 9/32" x 1 3/8"	8/32
2	2102160	170 Stainless steel	160mm c.c.	216 x 35mm	8 1/2" x 1 3/8"	8/32
3	2102192	170 Stainless steel	192mm c.c.	248 x 35mm	9 3/4" x 1 3/8"	8/32
4	70031224	170 Stainless steel	224mm c.c.	256 x 35mm	10 3/32" x 1 3/8"	M4
5	70031192	170 Stainless steel	192mm c.c.	223 x 35mm	8 25/32" x 1 3/8"	M4
6	70031128	170 Stainless steel	128mm c.c.	160 x 35mm	6 5/16" x 1 3/8"	M4
7	30134	170 Stainless steel	96mm c.c.	117 x 28mm	4 19/32" x 1 3/32"	8/32
8	30135	170 Stainless steel	128mm c.c.	153 x 28mm	6 1/32" x 1 3/32"	8/32
9	75100	171 Stainless steel	100mm c.c.	108 x 40mm	4 1/4" x 1 9/16"	Screw incl.
10	75075	171 Stainless steel	75mm c.c.	83 x 40mm	3 9/32" x 1 9/16"	Screw incl.
11	3409128	170 Stainless steel	128mm c.c.	147 x 32mm	5 23/32" x 1 1/4"	8/32

REF. NO.	COLOR FINISH	MATERIAL DESCRIPTION	DIMENSION C.C. / Ø	OVERALL DIMENSION (L/W x P/H) METRIC	OVERALL DIMENSION (L/W x P/H) IMPERIAL	SCREW NAIL
12	340996	170 Stainless steel	96mm c.c.	113 x 32mm	4 7/16" x 1 1/4"	8/32
13	34013	170 Stainless steel	Ø 25mm	25 x 26mm	1" x 1 1/32"	8/32
14	34015	170 Stainless steel	Ø 30mm	30 x 32mm	1 3/16" x 1 1/4"	8/32
15	2105160	170 Stainless steel	160mm c.c.	190 x 35mm	7 15/32" x 1 3/8"	8/32
16	2105128	170 Stainless steel	128mm c.c.	154 x 35mm	6 1/16" x 1 3/8"	8/32
17	2105096	170 Stainless steel	96mm c.c.	120 x 35mm	4 23/32" x 1 3/8"	8/32
18	245	170 Stainless steel	96mm c.c.	103 x 30mm	4 1/16" x 1 3/16"	8/32
19	33205	170 Stainless steel	96mm c.c.	105 x 30mm	4 1/8" x 1 3/16"	8/32
20	75126	171 Stainless steel	106mm c.c.	120 x 27mm	4 23/32" x 1 1/16"	Screw incl.
21	75098	170 Stainless steel		23 x 88mm	29/32" x 3 15/32"	Screw incl.
22	75070	170 Stainless steel		70 x 50mm	2 3/4" x 1 31/32"	Screw incl.



REF. NO.	COLOR FINISH	MATERIAL DESCRIPTION	DIMENSION C.C. / Ø	OVERALL DIMENSION (L x P) METRIC	OVERALL DIMENSION (L x P) IMPERIAL	SCREW NAIL
1	13411320	10 Aluminium	320mm c.c.	345 x 21mm	13 19/32" x 13/16"	M4
	13411224	10 Aluminium	224mm c.c.	249 x 21mm	9 13/16" x 13/16"	M4
	13411160	10 Aluminium	160mm c.c.	184 x 21mm	7 1/4" x 13/16"	M4
	13411128	10 Aluminium	128mm c.c.	152 x 21mm	5 31/32" x 13/16"	M4
2	13901608	10 Aluminium	608mm c.c.	660 x 32mm	26" x 1 1/4"	M4
3	13901324	10 Aluminium	320mm c.c.	370 x 32mm	14 9/16" x 1 1/4"	M4
4	35063128	10 Aluminium	128mm c.c.	145 x 31mm	5 23/32" x 1 7/32"	8/32
5	13101128	10 Aluminium	128mm c.c.	152 x 22mm	5 31/32" x 7/8"	M4
	13101160	10 Aluminium	160mm c.c.	184 x 22mm	7 1/4" x 7/8"	M4
	13101192	10 Aluminium	192mm c.c.	216 x 22mm	8 1/2" x 7/8"	M4
	13101224	10 Aluminium	224mm c.c.	248 x 22mm	9 3/4" x 7/8"	M4
	13101320	10 Aluminium	320mm c.c.	345 x 22mm	13 19/32" x 7/8"	M4
6	460720224	10 Aluminium	224mm c.c.	270 x 24mm	10 5/8" x 15/16"	8/32
7	460720192	10 Aluminium	192mm c.c.	240 x 24mm	9 7/16" x 15/16"	8/32

REF. NO.	COLOR FINISH	MATERIAL DESCRIPTION	DIMENSION C.C. / Ø	OVERALL DIMENSION (L x P) METRIC	OVERALL DIMENSION (L x P) IMPERIAL	SCREW NAIL
8	460720	10 Aluminium	20 x 20mm	20 x 24mm	25/32" x 15/16"	8/32
9	460715224	10 Aluminium	224mm c.c.	270 x 24mm	10 5/8" x 15/16"	8/32
10	460715192	10 Aluminium	192mm c.c.	240 x 24mm	9 7/16" x 15/16"	8/32
11	460715	10 Aluminium	15 x 15mm	15 x 24mm	19/32" x 15/16"	8/32
12	4670160	10 Aluminium	160mm c.c.	230 x 20mm	9" x 25/32"	8/32
13	467096	10 Aluminium	96mm c.c.	120 x 20mm	4 23/32" x 25/32"	8/32
14	467032	10 Aluminium	32mm c.c.	50 x 20mm	1 31/32" x 25/32"	8/32
15	4601128	10 Aluminium	128mm c.c.	150 x 20mm	5 29/32" x 25/32"	8/32
16	460196	10 Aluminium	96mm c.c.	120 x 20mm	4 23/32" x 25/32"	8/32
17	460132	10 Aluminium	32mm c.c.	50 x 20mm	1 31/32" x 25/32"	8/32
18	4604128	10 Aluminium	128mm c.c.	150 x 16mm	5 29/32" x 5/8"	8/32
19	460496	10 Aluminium	96mm c.c.	120 x 16mm	4 23/32" x 5/8"	8/32
20	460432	10 Aluminium	32mm c.c.	50 x 16mm	1 31/32" x 5/8"	8/32





REF. NO.	COLOR FINISH	MATERIAL DESCRIPTION	DIMENSION C.C. / Ø	OVERALL DIMENSION (L x P) METRIC	OVERALL DIMENSION (L x P) IMPERIAL	SCREW NAIL	
1	1414512	BB, 142, 909	Metal	512mm c.c.	526 x 39mm	20 3/4" x 1 9/16"	M4
2	1414288	BB, 142, 909	Metal	288mm c.c.	303 x 40mm	11 15/16" x 1 9/16"	M4
3	1414128	BB, 142, 909	Metal	128mm c.c.	142 x 40mm	5 19/32" x 1 9/16"	M4
4	49430	BB, 142, 909	Metal	30 x 30mm	30 x 26mm	1 3/16" x 1 1/32"	M4
5	4948	BB, 142, 909	Metal	96mm c.c.	118 x 22mm	4 5/8" x 7/8"	M4
6	7773160	81, 93, 902	Metal	160mm c.c.	240 x 36mm	9 7/16" x 1 3/8"	M4

REF. NO.	COLOR FINISH	MATERIAL DESCRIPTION	DIMENSION C.C. / Ø	OVERALL DIMENSION (L x P) METRIC	OVERALL DIMENSION (L x P) IMPERIAL	SCREW NAIL	
7	7811160	908	Metal	160mm c.c.	175 x 45mm	6 7/8" x 1 3/4"	M4
8	7811128	908	Metal	128mm c.c.	143 x 45mm	5 5/8" x 1 3/4"	M4
9	7767192	81, 93, 902	Metal	192mm c.c.	240 x 26mm	9 7/16" x 1 1/32"	M4
10	776732	81, 93, 902	Metal	32mm c.c.	42 x 26mm	1 5/8" x 1 1/32"	M4
11	777364	81, 93, 902	Metal	64mm c.c.	120 x 36mm	4 11/16" x 1 3/8"	M4



REF. NO.	COLOR FINISH	MATERIAL DESCRIPTION	DIMENSION C.C. / Ø	OVERALL DIMENSION (L x P) METRIC	OVERALL DIMENSION (L x P) IMPERIAL	SCREW NAIL	
1	33652160	909	Forged iron	160mm c.c.	224 x 36mm	8 13/16" x 1 13/32"	8/32
2	440475	909	Forged iron	75 x 36mm	2 15/16" x 1 13/32"		8/32
3	702396	342	Metal	96mm c.c.	170 x 32mm	6 11/16" x 1 1/4"	M4
4	702496	342	Metal	96mm c.c.	170 x 32mm	6 11/16" x 1 1/4"	M4
5	98235	342	Metal	Ø 35mm	35 x 36mm	1 3/8" x 1 13/32"	M4
6	98145	342	Metal	45 x 45mm	45 x 48mm	1 25/32" x 1 7/8"	M4
7	7013160	242	Metal	160mm c.c.	206 x 27mm	8 1/8" x 1 1/16"	M4
8	701396	242	Metal	96mm c.c.	142 x 27mm	5 19/32" x 1 1/16"	M4
9	98760	242	Metal	60 x 60mm	60 x 27mm	2 3/8" x 1 1/16"	M4
10	33651128	909	Forged iron	128mm c.c.	192 x 32mm	7 9/16" x 1 1/4"	8/32
11	392726	909	Forged iron	26 x 25mm	26 x 25mm	1 1/32" x 1"	8/32
12	7440128	903	Forged iron	128mm c.c.	195 x 31mm	7 11/16" x 1 7/32"	M4

REF. NO.	COLOR FINISH	MATERIAL DESCRIPTION	DIMENSION C.C. / Ø	OVERALL DIMENSION (L x P) METRIC	OVERALL DIMENSION (L x P) IMPERIAL	SCREW NAIL	
13	744096	903	Forged iron	96mm c.c.	160 x 31mm	6 5/16" x 1 7/32"	M4
14	807030	903	Forged iron	31 x 31mm	31 x 30mm	1 7/32" x 1 3/16"	M4
15	7430128	903	Forged iron	128mm c.c.	194 x 33mm	7 5/8" x 1 5/16"	M4
16	743096	903	Forged iron	96mm c.c.	158 x 33mm	6 7/32" x 1 5/16"	M4
17	806031	903	Forged iron	Ø 31mm	31 x 37mm	1 7/32" x 1 15/32"	M4
18	2188160	161	Metal	160mm c.c.	198 x 29mm	7 25/32" x 1 1/8"	M4
19	725825	161	Metal	Ø 25mm	25 x 22mm	1" x 7/8"	M4
20	7858128	142	Metal	128mm c.c.	149 x 25mm	5 7/8" x 1"	M4
21	786132	142	Metal	32mm c.c.	92 x 22mm	3 5/8" x 7/8"	M4
22	717	910	Metal	128mm c.c.	149 x 31mm	5 7/8" x 1 7/32"	M4
23	8770	910	Metal	39 x 17mm	39 x 25mm	1 17/32" x 1"	M4

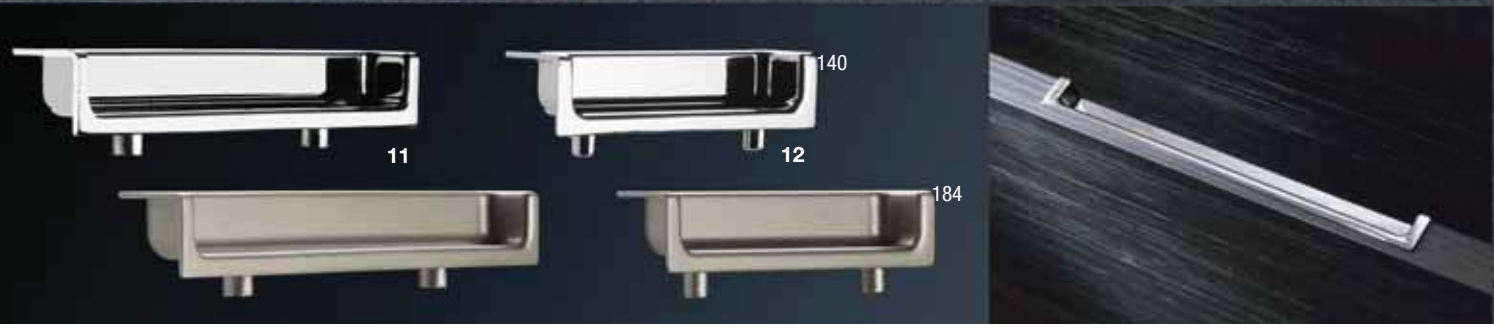

REF. NO.	COLOR FINISH	MATERIAL DESCRIPTION	DIMENSION C.C. / Ø	DRILL HOLE SIZE (L x W x D) METRIC	DRILL HOLE SIZE (L x W x D) IMPERIAL	SCREW NAIL	
1	72117	195 Metal		45 x 12 x 10mm	1 25/32" x 15/32" x 13/32"	M4	
2	61672150	195 Metal		45 x 45 x 10mm	1 25/32" x 1 25/32" x 13/32"	M4	
3	721132	195 Metal	64mm c.c.	127 x 45 x 10mm	5" x 1 25/32" x 13/32"	M4	
4	61642732*	174 Metal		Ø 26mm	Ø 21 x 27mm	13/16" x 1 1/16"	
5	714213	183 Metal		210 x 33 x 10mm	8 9/32" x 1 5/16" x 13/32"	M4	
6	714143	183 Metal		140 x 31 x 10mm	5 1/2" x 1 7/32" x 13/32"	M4	
7	72965	183 Metal		Ø 65mm	Ø 57 x 9mm	Ø 2 1/4" x 11/32"	M4

REF. NO.	COLOR FINISH	MATERIAL DESCRIPTION	DIMENSION C.C. / Ø	DRILL HOLE SIZE (L x W x D) METRIC	DRILL HOLE SIZE (L x W x D) IMPERIAL	SCREW NAIL
8	1026140*	195 Metal		Ø 95 x 25 x 23mm	Ø 3 3/4" x 1" x 29/32"	
9	616743128	174 Metal	128mm c.c.	134 x 26 x 14mm	5 9/32" x 1 1/32" x 9/16"	M4
10	616748160	174 Metal	160mm c.c.	166 x 40 x 14mm	6 17/32" x 1 9/16" x 9/16"	M4
11	210196	140, 184 Zinc	96mm c.c.	177mm x 19mm	7" x 3/4"	Recessed & glued
12	210164	140, 184 Zinc	64mm c.c.	97mm x 19mm	3 13/16" x 3/4"	Recessed & glued

Legend: L= Length W= Width D= Depth  
\* Push button



REF. NO.	COLOR FINISH	MATERIAL DESCRIPTION	DIMENSION C.C. / Ø	OVERALL DIMENSION METRIC	OVERALL DIMENSION (L x P) IMPERIAL	SCREW NAIL
1	616788160	195 Metal	160mm c.c.	180 x 16mm	7 3/32" x 5/8"	M4
2	61678832	195 Metal	32mm c.c.	51 x 16mm	2" x 5/8"	M4
3	136557	195 Metal	16mm c.c.	57 x 23mm	2 1/4" x 29/32"	M4
	136545	195 Metal	16mm c.c.	45 x 23mm	1 25/32" x 29/32"	M4
4	17514160	195 Metal	160mm c.c.	200 x 24mm	7 7/8" x 15/16"	M4
5	616752128	195 Metal	128mm c.c.	175 x 22mm	6 7/8" x 7/8"	M4
6	61675296	195 Metal	96mm c.c.	144 x 22mm	5 21/32" x 7/8"	M4
7	2170096	174 Metal	96mm c.c.	160 x 24mm	6 5/16" x 15/16"	M4
8	2170016	174 Metal	16mm c.c.	40 x 20mm	1 9/16" x 25/32"	M4

REF. NO.	COLOR FINISH	MATERIAL DESCRIPTION	DIMENSION C.C. / Ø	OVERALL DIMENSION METRIC	OVERALL DIMENSION (L x P) IMPERIAL	SCREW NAIL
9	2169796	174 Metal	96mm c.c.	104 x 24mm	4 3/32" x 15/16"	M4
10	2169732	174 Metal	32mm c.c.	40 x 24mm	1 9/16" x 15/16"	M4
11	616886160	195 Metal	160mm c.c.	176 x 15mm	6 15/16" x 19/32"	M4
12	61688696	195 Metal	96mm c.c.	110 x 15mm	4 11/32" x 19/32"	M4
13	61688632	195 Metal	32mm c.c.	45 x 15mm	1 25/32" x 19/32"	M4
14	74538050	195 Metal	16mm c.c.	50 x 25mm	1 31/32" x 1"	M4
15	74537938	195 Metal	16mm c.c.	38 x 21mm	1 1/2" x 13/16"	M4
16	74537825	195 Metal	25 x 25mm	25 x 17mm	1" x 21/32"	M4



# MURANO GLASS AND CRYSTAL



REF. NO.	COLOR FINISH	MATERIAL DESCRIPTION	DIMENSION C.C. / Ø	OVERALL DIMENSION (L x P) METRIC	OVERALL DIMENSION (L x P) IMPERIAL	SCREW NAIL
1	9030 AE/11, AE/12,130/11, 140/11, 140/95, 195/11, 195/12	Murano glass	Ø 30mm	30 x 35mm	1 3/16" x 1 3/8"	M4
2	503640 140/11	Metal & Crystal	Ø 40mm	40 x 49mm	1 9/16" x 1 15/16"	M4
3	40440 11/30	Glass	Ø 48mm	48 x 39mm	1 7/8" x 1 17/32"	M4
4	1830 130/21, 140/22	Murano glass	Ø 30mm	30 x 26mm	1 3/16" x 1 1/32"	M4
5	1530 130/12, 140/12, 142/12, 195/12	Murano glass	Ø 30mm	30 x 34mm	1 3/16" x 1 11/32"	M4

REF. NO.	COLOR FINISH	MATERIAL DESCRIPTION	DIMENSION C.C. / Ø	OVERALL DIMENSION (L x P) METRIC	OVERALL DIMENSION (L x P) IMPERIAL	SCREW NAIL
6	276 130/11	24 K gold & crystal	Ø 19mm	19 x 22mm	3/4" x 7/8"	M4
		BORB/11, 195/11 Metal & crystal	Ø 19mm	19 x 22mm	3/4" x 7/8"	M4
7	9912 130/11	Brass & crystal	Ø 30mm	30 x 37mm	1 3/16" x 1 15/32"	M4
8	9923 130/18, 140/18	Brass & crystal	Ø 25mm	25 x 34mm	1" x 1 11/32"	M4
9	9932 130/11	24 K gold & crystal	Ø 30mm	30 x 39mm	1 3/16" x 1 17/32"	M4
10	9993 130/11	Brass & crystal	Ø 25mm	25 x 36mm	1" x 1 13/32"	M4
11	9933 130/11	Brass & crystal	Ø 20mm	20 x 29mm	25/32" x 1 5/32"	M4

# GLASS AND CRYSTAL



REF. NO.	COLOR FINISH	MATERIAL DESCRIPTION	DIMENSION C.C. / Ø	OVERALL DIMENSION METRIC	OVERALL DIMENSION (L x P) IMPERIAL	SCREW NAIL
1	778825 11, 90	Glass	25 x 25mm	25 x 26mm	1" x 1 1/32"	M4
2	202416 195/11	Metal & glass	16mm c.c.	102 x 25mm	4" x 1"	M4
3	2024128 195/11	Metal & glass	128mm c.c.	245 x 25mm	9 5/8" x 1"	M4
4	202716 195/11	Metal & glass	16mm c.c.	35 x 25mm	1 3/8" x 1"	M4
5	307932 140/11, 140/13	Metal & Crystal	32mm c.c.	112 x 31mm	4 3/8" x 1 3/16"	M4

REF. NO.	COLOR FINISH	MATERIAL DESCRIPTION	DIMENSION C.C. / Ø	OVERALL DIMENSION METRIC	OVERALL DIMENSION (L x P) IMPERIAL	SCREW NAIL
6	307832 140/11, 140/13	Metal & Crystal	32mm c.c.	80 x 31mm	3 1/8" x 1 3/16"	M4
7	307748 140/11, 140/13	Metal & Crystal		48 x 31mm	1 7/8" x 1 3/16"	M4
8	307516 140/11, 140/13	Metal & Crystal	Ø 16mm	16 x 31mm	5/8" x 1 3/16"	M4
9	21719 140	Metal & Crystal	Ø 18mm	18 x 18mm	23/32" x 23/32"	M4





REF. NO.	COLOR FINISH	MATERIAL DESCRIPTION	DIMENSION C.C. / Ø	OVERALL DIMENSION (L x P) METRIC	OVERALL DIMENSION (L x P) IMPERIAL	SCREW NAIL
1	73750 79/140, 110/140	Durohorn®/Metal	16mm c.c.	58 x 22mm	2 1/4" x 13/16"	M4
2	737192 79/140, 110/140	Durohorn®/Metal	192mm c.c.	232 x 28mm	9 1/8" x 1 1/16"	M4
3	685 195/ 11,12	Metacryl®	160mm c.c.	180 x 47mm	7 3/32" x 1 27/32"	M4
4	833 12, 17, 749	Duroplus®	Ø 29mm	29 x 21mm	1 5/32" x 13/16"	M4

REF. NO.	COLOR FINISH	MATERIAL DESCRIPTION	DIMENSION C.C. / Ø	OVERALL DIMENSION (L x P) METRIC	OVERALL DIMENSION (L x P) IMPERIAL	SCREW NAIL
5	835 12, 17, 749	Duroplus®	128mm c.c.	157 x 21mm	6 3/16" x 13/16"	M4
6	341 195/ 12, 14, 78	Metacryl®	Ø 19mm	19 x 24mm	3/4" x 15/16"	M4
7	21720160 195/ 11, 120, 750	Metal/acrylic	160mm c.c.	175 x 30mm	6 7/8" x 1 3/16"	M4
8	21722 195/ 11, 120, 750	Metal/acrylic	32mm c.c.	64 x 14mm	2 17/32" x 9/16"	M4

# METAL / WOOD OR LEATHER



REF. NO.	COLOR FINISH	MATERIAL DESCRIPTION	DIMENSION C.C. / Ø	OVERALL DIMENSION (L x P) METRIC	OVERALL DIMENSION (L x P) IMPERIAL	SCREW NAIL
1	2170096	90 Metal /Leather	96mm c.c.	160 x24mm	6 5/16" x 15/16"	M4
2	2170016	90 Metal /Leather	16mm c.c.	40 x 20mm	1 9/16" x 25/32"	M4
3	58500	195/32.1 Metal /Wood	160mm c.c.	234 x 34mm	9 3/16" x 1 11/32"	M4
4	59917	195/32.1 Metal /Wood	16mm c.c.	32 x 34mm	1 1/4 " x1 11/32"	M4
5	616791160	195/32.1 Metal /Wood	160mm c.c.	173 x 25mm	6 13/16" x 1"	M4
6	61641033	195/32.1 Metal /Wood	34 x 34mm	34 x 29mm	1 11/32" x 15/32"	M4
7	745366160	195/ 45, 90 Metal /Leather	160mm c.c.	188 x 14mm	7 13/32" x 9/16"	M4

REF. NO.	COLOR FINISH	MATERIAL DESCRIPTION	DIMENSION C.C. / Ø	OVERALL DIMENSION (L x P) METRIC	OVERALL DIMENSION (L x P) IMPERIAL	SCREW NAIL
8	74511216	195/ 45, 90 Metal /Leather	16mm c.c.	45 x 8mm	1 25/32" x 5/16"	M4
9	745204224	195/ 45, 90 Metal /Leather	224mm c.c.	268 x 35mm	10 9/16" x 1 3/8"	M4
10	745116128	195/ 45, 90 Metal /Leather	128mm c.c.	172 x 35mm	6 25/32" x 1 3/8"	M4
11	74511516	195/ 45, 90 Metal /Leather	16mm c.c.	78 x 35mm	3 1/16" x 13/8"	M4
12	318190	140 Metal /Leather		15 x 25mm	19/32" x 1"	M4
13	21717128	174/90 Rubber	128mm c.c.	173 x 30mm	6 13/16" x 13/16"	M4
14	21716	174/90 Rubber		45 x 30mm	1 25/32" x 1 3/16"	M4



\*ANTIMICROBIAL

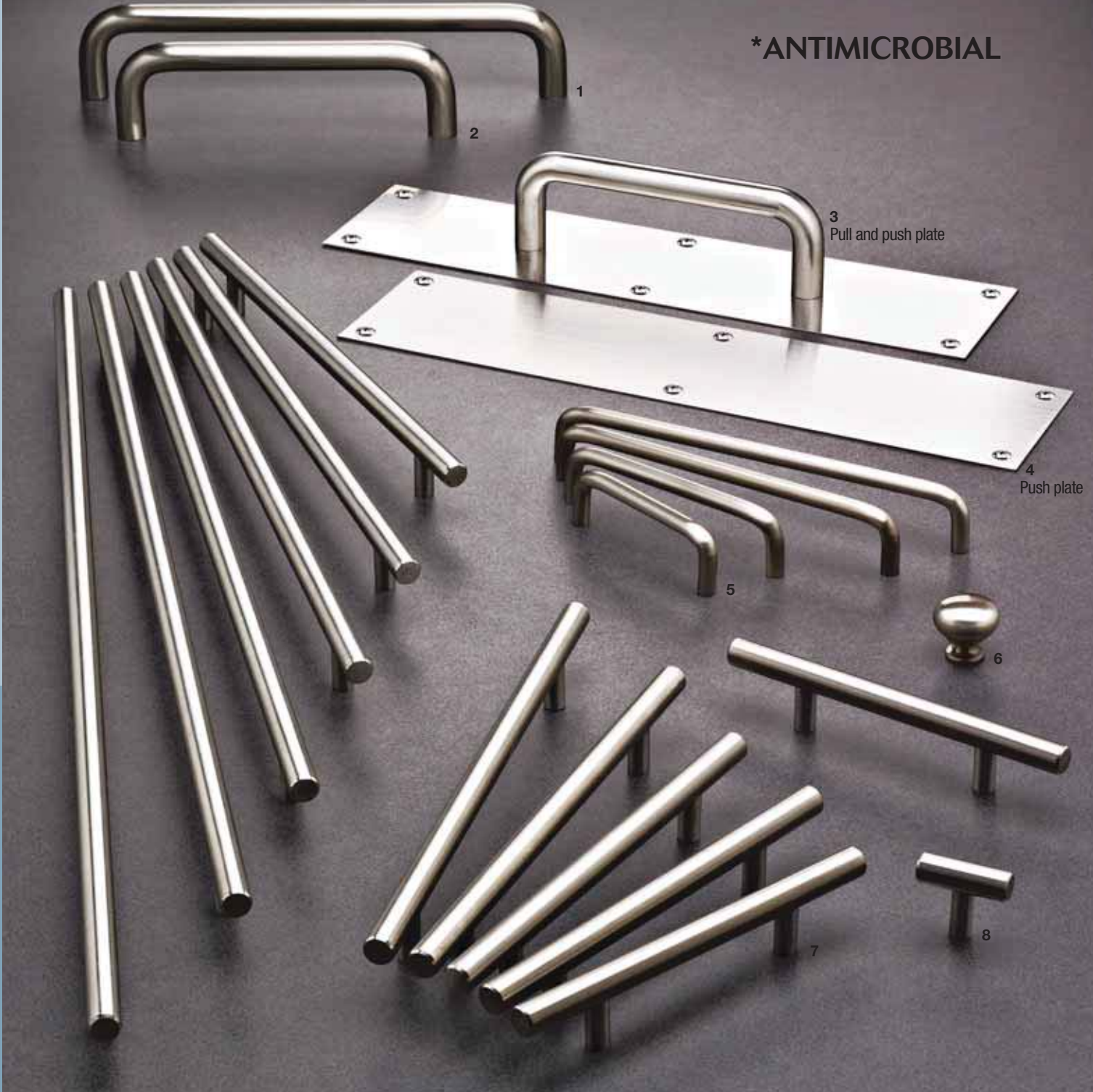

REF. NO.	COLOR FINISH	MATERIAL DESCRIPTION	DIMENSION C.C. / Ø	OVERALL DIMENSION (L x P) METRIC	OVERALL DIMENSION (L x P) IMPERIAL	SCREW NAIL	
1	938305	195/AB	Brass	305mm c.c.	323 x 63mm	12 3/4" x 2 1/2"	1/4-20
2	938203	195/AB	Brass	203mm c.c.	222 x 63mm	8 3/4" x 2 1/2"	1/4-20
3	14230	170/AB	Stainless steel	7" c.c.	381 x 89mm	15" x 3 1/2"	Screw incl.
		ABL	Brass	7" c.c.	381 x 89mm	15" x 3 1/2"	Screw incl.
4	D010441	170/AB	Stainless steel	381 x 89mm	15" x 3 1/2"	Screw incl.	
		ABL	Brass	381 x 89mm	15" x 3 1/2"	Screw incl.	
5	938224	195/AB	Brass	224mm c.c.	234 x 29mm	9 1/4" x 1 1/8"	8/32
	938192	195/AB	Brass	192mm c.c.	202 x 29mm	7 15/16" x 1 1/8"	8/32
	938128	195/AB	Brass	128mm c.c.	139 x 29mm	5 1/2" x 1 1/8"	8/32
	93896	195/AB	Brass	96mm c.c.	106 x 29mm	4 3/16" x 1 1/8"	8/32
	93232	195/AB	Brass	Ø 32mm	32 x 30mm	1 1/4" x 1 3/16"	8/32

\* This product is not a disinfectant and does not protect the user or others against food-borne illnesses or disease. Always use proper hygiene and cleaning procedures.

REF. NO.	COLOR FINISH	MATERIAL DESCRIPTION	DIMENSION C.C. / Ø	DIMENSION DOOR	OVERALL DIMENSION (L x P) METRIC	OVERALL DIMENSION (L x P) IMPERIAL	SCREW NAIL	
7	348796	170/AB	Stainless steel	96mm c.c.	176 x 35mm	6 15/16" x 1 3/8"	8/32	
	3487105	170/AB	Stainless steel	105mm c.c.	12"	185 x 35mm	7 9/32" x 1 3/8"	8/32
	3487128	170/AB	Stainless steel	128mm c.c.	208 x 35mm	8 3/16" x 1 3/8"	8/32	
	3487143	170/AB	Stainless steel	143mm c.c.	13 1/2"	223 x 35mm	8 25/32" x 1 3/8"	8/32
	3487181	170/AB	Stainless steel	181mm c.c.	15"	261 x 35mm	10 9/32" x 1 3/8"	8/32
	3487219	170/AB	Stainless steel	219mm c.c.	16 1/2"	299 x 35mm	11 25/32" x 1 3/8"	8/32
	3487257	170/AB	Stainless steel	257mm c.c.	18"	337 x 35mm	13 9/32" x 1 3/8"	8/32
	3487333	170/AB	Stainless steel	333mm c.c.	21"	413 x 35mm	16 1/4" x 1 3/8"	8/32
	3487410	170/AB	Stainless steel	410mm c.c.	24"	490 x 35mm	19 9/32" x 1 3/8"	8/32
	3487486	170/AB	Stainless steel	486mm c.c.	27"	566 x 35mm	22 9/32" x 1 3/8"	8/32
	3487562	170/AB	Stainless steel	562mm c.c.	30"	642 x 35mm	25 9/32" x 1 3/8"	8/32
	3487638	170/AB	Stainless steel	638mm c.c.	33"	718 x 35mm	28 9/32" x 1 3/8"	8/32
	8	348740	170/AB	Stainless steel		40 x 35mm	1 9/16" x 1 3/8"	8/32



\*Decorative hardware that contributes toward satisfying Credit 4.1 and 4.2 Recycled Content for LEED® certification.



REF. NO.	COLOR FINISH	MATERIAL DESCRIPTION	DIMENSION C.C. / Ø	OVERALL DIMENSION (L x P) METRIC	OVERALL DIMENSION (L x P) IMPERIAL	SCREW NAIL
1	229310*	195 Solid brass	10" c.c.	355 x 39mm	14" x 1 17/32"	8/32
2	22936*	195 Solid brass	6" c.c.	202 x 39mm	7 15/16" x 1 17/32"	8/32
3	2293*	195 Solid brass	3" c.c.	100 x 30mm	3 15/16" x 1 3/16"	8/32
4	2294*	195 Solid brass	32 x 32mm	32 x 30mm	1 1/4" x 1 3/16"	8/32
5	1019258*	OSB Solid brass	8" c.c.	230 x 39mm	9 1/16" x 1 17/32"	8/32

REF. NO.	COLOR FINISH	MATERIAL DESCRIPTION	DIMENSION C.C. / Ø	OVERALL DIMENSION (L x P) METRIC	OVERALL DIMENSION (L x P) IMPERIAL	SCREW NAIL
6	101925*	OSB Solid brass	3 1/2" c.c.	110 x 30mm	4 11/32" x 1 3/16"	8/32
7	910138*	OSB Solid brass	Ø 38mm	38 x 36mm	1 1/2" x 1 13/32"	8/32
8	910128*	OSB Solid brass	Ø 28mm	28 x 26mm	1 3/32" x 1 1/32"	8/32
9	4512128*	AE Solid brass	8" c.c.	220 x 51mm	8 5/8" x 2"	1/4-20
10	125528*	AE Solid brass	Ø 1 1/4"	32 x 29mm	1 1/4" x 1 1/8"	8/32
11	821183*	AE Solid brass	3" c.c.	117 x 28mm	4 19/32" x 1 3/32"	8/32



# APPLIANCE PULLS

Our new contemporary collection is available in oversize lengths.

Perfect for refrigerators , pantry doors, wide drawers or tall doors.



REF. NO.	COLOR FINISH	MATERIAL DESCRIPTION	DIMENSION C.C. / Ø	OVERALL DIMENSION (L x P)		SCREW NAIL
			METRIC	METRIC	IMPERIAL	
1	443736	195 Aluminium	736mm c.c.	817 x 55mm	32 5/32" x 2 5/32"	M4
2	443544	195 Aluminium	544mm c.c.	625 x 55mm	24 19/32" x 2 5/32"	M4
3	150256	195 Metal	256mm c.c.	277 x 36mm	10 29/32" x 1 13/32"	8/32
4	15018	195 Metal	18" c.c.	479 x 36mm	18 27/32" x 1 13/32"	8/32

REF. NO.	COLOR FINISH	MATERIAL DESCRIPTION	DIMENSION C.C. / Ø	OVERALL DIMENSION (L x P)		SCREW NAIL
			METRIC	METRIC	IMPERIAL	
5	441544	195 Aluminium	544mm c.c.	556 x 44mm	21 7/8" x 1 23/32"	M4
6	441448	195 Aluminium	448mm c.c.	460 x 44mm	18 1/8" x 1 23/32"	M4
7	447390	174 Metal	387mm c.c.	420 x 36mm	16 17/32" x 1 13/32"	8/32
8	2602	145 Metal	96mm c.c.	126 x 35mm	4 31/32" x 1 3/8"	8/32

Logo provided by Sub-Zero Freezer Inc. - www.subzero.com



## APPLIANCE PULLS



REF. NO.	COLOR FINISH	MATERIAL DESCRIPTION	DIMENSION C.C. / Ø	OVERALL DIMENSION (L x P)		SCREW NAIL	REF. NO.	COLOR FINISH	MATERIAL DESCRIPTION	DIMENSION C.C. / Ø	OVERALL DIMENSION (L x P)		SCREW NAIL
				METRIC	IMPERIAL					METRIC	IMPERIAL		
1	616941320	195 Metal	320mm c.c.	448 x 32mm	17 5/8" x 1 1/4"	M4	5	719762	195 Metal	762mm c.c.	806 x 40mm	31 23/32" x 1 9/16"	8/32
2	1003500	140/195 Metal	500mm c.c.	466 x 38mm	18 11/32" x 1 1/2"	M6	6	719160	195 Metal	160mm c.c.	202 x 40mm	7 15/16" x 1 9/16"	8/32
3	1003128	140/195 Metal	128mm c.c.	170 x 35mm	6 11/16" x 1 3/8"	M4	7	719128	195 Metal	128mm c.c.	170 x 40mm	6 11/16" x 1 9/16"	8/32
4	446600	195 Aluminium	600mm c.c.	627 x 44mm	24 11/16" x 1 23/32"	8/32	8	71996	195 Metal	96mm c.c.	139 x 40mm	5 15/16" x 1 9/16"	8/32





APPLIANCE PULLS



REF. NO.	COLOR FINISH	MATERIAL DESCRIPTION	DIMENSION C.C. / Ø	OVERALL DIMENSION METRIC	OVERALL DIMENSION (L x P) IMPERIAL	SCREW NAIL
1	765304 AE, BORB, 143, 180, 195	Metal	12" c.c.	354 x 50mm	13 15/16" x 1 15/16"	M6
2	392112 BORB, 180, 195	Metal	12" c.c.	335 x 69mm	13 3/16" x 2 11/16"	M6
3	502112 BORB, 180, 195	Metal	12" c.c.	332 x 56mm	13 1/16" x 2 3/16"	M6

REF. NO.	COLOR FINISH	MATERIAL DESCRIPTION	DIMENSION C.C. / Ø	OVERALL DIMENSION METRIC	OVERALL DIMENSION (L x P) IMPERIAL	SCREW NAIL
4	740304 195, AE, BORB, 143, 180	Metal	305mm c.c.	329 x 50mm	13" x 1 15/16"	M6
5	8710256 195, AE, BORB, 142	Metal	256mm c.c.	311 x 44mm	12 1/4" x 1 11/16"	8/32
6	5810256 195, BORB, R3, 908	Metal	256mm c.c.	306 x 47mm	12" x 1 7/8"	8/32

# APPLIANCE PULLS



REF. NO.	COLOR FINISH	MATERIAL DESCRIPTION	DIMENSION C.C. / Ø	OVERALL DIMENSION (L x P) METRIC	OVERALL DIMENSION (L x P) IMPERIAL	SCREW NAIL
1	82259 AE, BORB, 195	Metal	12" c.c.	325 x 60mm	12 25/32" x 2 3/8"	M6
2	82290 AE, BORB, 195	Metal	12" c.c.	350 x 55mm	13 3/4" x 2 5/32"	M6
	2282290** AE, BORB, 195	Metal	12" c.c.	350 x 55mm	13 3/4" x 2 5/32"	M6
3	82718 AE, BORB, 195	Metal	12" c.c.	338 x 55mm	13 5/16" x 2 5/32"	M6
4	82262 AE, BORB, 195	Metal	12" c.c.	335 x 43mm	13 3/16" x 1 11/16"	M6
5	82555 AE, BORB, 195	Metal	12" c.c.	412 x 56mm	16 3/16" x 2 7/32"	M6
6	82300 AE, BORB, 195	Metal	12" c.c.	415 x 52mm	16 5/16" x 2 1/16"	M6
7	821207 AE, BORB, 195	Metal	12" c.c.	355 x 52mm	14" x 2 1/16"	M6

REF. NO.	COLOR FINISH	MATERIAL DESCRIPTION	DIMENSION C.C. / Ø	OVERALL DIMENSION (L x P) METRIC	OVERALL DIMENSION (L x P) IMPERIAL	SCREW NAIL
8	821211 AE, BORB, 195	Metal	12" c.c.	328 x 67mm	12 29/32" x 2 5/8"	M6
	22821211** AE, BORB, 195	Metal	12" c.c.	328 x 67mm	12 29/32" x 2 5/8"	M6
9	444405 BB, 130	Solid brass	212mm c.c.	405 x 76mm	15 15/16" x 3"	M6

\*\* Back to back handle

# APPLIANCE PULLS



REF. NO.	COLOR FINISH	MATERIAL DESCRIPTION	DIMENSION C.C. / Ø	OVERALL DIMENSION METRIC	OVERALL DIMENSION (L x P) IMPERIAL	SCREW NAIL
1	11725384 BB, 800, 908	Forged iron	384mm c.c.	610 x 63mm	24 1/32" x 2 15/32"	1/4-20
2	11725672 BB, 800, 908	Forged iron	672mm c.c.	900 x 63mm	35 7/16" x 2 15/32"	1/4-20
3	1714480	908 Forged iron	480mm c.c.	505 x 79mm	19 7/8" x 3 1/8"	1/4-20

REF. NO.	COLOR FINISH	MATERIAL DESCRIPTION	DIMENSION C.C. / Ø	OVERALL DIMENSION METRIC	OVERALL DIMENSION (L x P) IMPERIAL	SCREW NAIL
4	1714305	908 Forged iron	305mm c.c.	331 x 79mm	13 1/32" x 3 1/8"	1/4-20
5	1714200	908 Forged iron	200mm c.c.	225 x 79mm	8 27/32" x 3 1/8"	1/4-20
6	448600	AE, BORB, ORB, 900, 908	Metal 600mm c.c.	612 x 68mm	24 3/32" x 2 11/16"	1/4-20

Nails and screws: see p.121

# CAST IRON COLLECTION

Made from an age-old material and finished with a simple or embossed design, these iron handles have a very solid and robust feel. The shadows they cast add yet another effect that is specific to the traditional style.



REF. NO.	COLOR FINISH	MATERIAL DESCRIPTION	DIMENSION C.C. / Ø	OVERALL DIMENSION (L x P) METRIC	OVERALL DIMENSION (L x P) IMPERIAL	SCREW NAIL	
1	37738	132, 800, 908	Cast iron	8" c.c.	254 x 28mm	10" x 1 3/32"	M4
2	377312	132, 800, 908	Cast iron	12" c.c.	370 x 28mm	14 9/16" x 1 3/32"	M4
3	377318	132, 800, 908	Cast iron	18" c.c.	507 x 28mm	20" x 1 3/32"	M4
4	377164	132, 800, 908	Cast iron	64mm c.c.	104 x 30mm	4 3/32" x 1 3/16"	M4
5	377296	132, 800, 908	Cast iron	96mm c.c.	160 x 25mm	6 5/16" x 1"	M4

REF. NO.	COLOR FINISH	MATERIAL DESCRIPTION	DIMENSION C.C. / Ø	OVERALL DIMENSION (L x P) METRIC	OVERALL DIMENSION (L x P) IMPERIAL	SCREW NAIL	
6	381196	132, 800, 908	Cast iron	96mm c.c.	160 x 25mm	6 5/16" x 1"	M4
7	377048	132, 800, 908	Cast iron	Ø 48mm	48 x 41mm	1 7/8" x 1 5/8"	M4
8	377038	132, 800, 908	Cast iron	Ø 38mm	38 x 34mm	1 1/2" x 1 11/32"	M4
9	377026	132, 800, 908	Cast iron	Ø 26mm	26 x 28mm	1 1/32" x 1 3/32"	M4

Nails and screws: see p.121





REF. NO.	COLOR FINISH	MATERIAL DESCRIPTION	DIMENSION C.G. / Ø	OVERALL DIMENSION (L x P) METRIC	OVERALL DIMENSION (L x P) IMPERIAL	SCREW NAIL
1	3741320 132, 800, 908	Cast iron	320mm c.c.	346 x 47mm	13 5/8" x 1 27/32"	M4
2	3741224 132, 800, 908	Cast iron	224mm c.c.	250 x 45mm	9 13/16" x 1 25/32"	M4
3	3741128 132, 800, 908	Cast iron	128mm c.c.	154 x 43mm	6 1/16" x 1 11/16"	M4
4	374264 132, 800, 908	Cast iron	64mm c.c.	116 x 34mm	4 9/16" x 1 11/32"	M4
5	3739 132, 800, 908	Cast iron		86 x 44mm	3 3/8" x 1 23/32"	M4
6	3161 132, 800, 908	Cast iron		40 x 30mm	1 9/16" x 1 3/16"	M4
7	3775128 132, 800, 908	Cast iron	128mm c.c.	143 x 40mm	5 5/8" x 1 9/16"	M4

REF. NO.	COLOR FINISH	MATERIAL DESCRIPTION	DIMENSION C.G. / Ø	OVERALL DIMENSION (L x P) METRIC	OVERALL DIMENSION (L x P) IMPERIAL	SCREW NAIL
8	3743160 132, 800, 908	Cast iron	160mm c.c.	168 x 30mm	6 5/8" x 1 3/16"	M4
9	3743128 132, 800, 908	Cast iron	128mm c.c.	136 x 30mm	5 11/32" x 1 3/16"	M4
10	374396 132, 800, 908	Cast iron	96mm c.c.	104 x 30mm	4 1/16" x 1 3/16"	M4
11	3257 132, 800, 908	Cast iron	35 x 35mm	35 x 24mm	1 3/8" x 15/16"	M4
12	373838 132, 800, 908	Cast iron	Ø 38mm	38 x 33mm	1 1/2" x 1 5/16"	M4
13	373834 132, 800, 908	Cast iron	Ø 34mm	34 x 29mm	1 11/32" x 1 5/32"	M4

Nails and screws: see p.121



REF. NO.	COLOR FINISH	MATERIAL DESCRIPTION	DIMENSION C.C. / Ø	OVERALL DIMENSION (L x P) METRIC	OVERALL DIMENSION (L x P) IMPERIAL	SCREW NAIL
1	365264 132, 800, 908	Cast iron	64mm c.c.	89 x 32mm	3 1/2" x 1 1/4"	M4
2	365018 132, 800, 908	Cast iron	18" c.c.	472 x 41mm	18 19/32" x 1 5/8"	M4
3	365012 132, 800, 908	Cast iron	12" c.c.	316 x 38mm	12 7/16" x 1 1/2"	M4
4	36508 132, 800, 908	Cast iron	8" c.c.	217 x 35mm	8 17/32" x 1 3/8"	M4
5	3650160 132, 800, 908	Cast iron	160mm c.c.	170 x 30mm	6 11/16" x 1 3/16"	M4

REF. NO.	COLOR FINISH	MATERIAL DESCRIPTION	DIMENSION C.C. / Ø	OVERALL DIMENSION (L x P) METRIC	OVERALL DIMENSION (L x P) IMPERIAL	SCREW NAIL
6	3650128 132, 800, 908	Cast iron	128mm c.c.	138 x 30mm	5 7/16" x 1 3/16"	M4
7	3651 132, 800, 908	Cast iron		24 x 30mm	15/16" x 1 3/16"	M4
8	361296 132, 800, 908	Cast iron	96mm c.c.	143 x 29mm	5 5/8" x 1 1/8"	M4
9	3611 132, 800, 908	Cast iron	36 x 36mm	36 x 31mm	1 13/32" x 1 7/32"	M4
10	364996 132, 800, 908	Cast iron	96mm c.c.	105 x 30mm	4 1/8" x 1 3/16"	M4

Nails and screws: see p.121





REF. NO.	COLOR FINISH	MATERIAL DESCRIPTION	DIMENSION C.C. / Ø	OVERALL DIMENSION (L x P) METRIC	OVERALL DIMENSION (L x P) IMPERIAL	SCREW NAIL
1	388912 FB, 132, 908	Cast iron	12" c.c.	318 x 61mm	12 1/2" x 2 3/8"	M6
2	38898 FB, 132, 908	Cast iron	8" c.c.	222 x 43mm	8 3/4" x 1 11/16"	M6
3	3889128 FB, 132, 908	Cast iron	128mm c.c.	140 x 39mm	5 1/2" x 1 17/32"	M4

REF. NO.	COLOR FINISH	MATERIAL DESCRIPTION	DIMENSION C.C. / Ø	OVERALL DIMENSION (L x P) METRIC	OVERALL DIMENSION (L x P) IMPERIAL	SCREW NAIL
4	388838 FB, 132, 908	Cast iron	Ø 38mm	38 x 29mm	1 1/2" x 1 1/8"	M4
5	388832 FB, 132, 908	Cast iron	Ø 32mm	32 x 25mm	1 1/4" x 1"	M4



REF. NO.	COLOR FINISH	MATERIAL DESCRIPTION	DIMENSION C.C. / Ø	OVERALL DIMENSION (L x P) METRIC	OVERALL DIMENSION (L x P) IMPERIAL	SCREW NAIL
1	388712	FB, 132, 908	Cast iron	12" c.c.	329 x 43mm	12 15/16" x 1 11/16" M6
2	388664	FB, 132, 908	Cast iron	64mm c.c.	100 x 50mm	3 15/16" x 1 31/32" M4
3	38878	FB, 132, 908	Cast iron	8" c.c.	227 x 43mm	8 15/16" x 1 11/16" M6

REF. NO.	COLOR FINISH	MATERIAL DESCRIPTION	DIMENSION C.C. / Ø	OVERALL DIMENSION (L x P) METRIC	OVERALL DIMENSION (L x P) IMPERIAL	SCREW NAIL
4	3887128	FB, 132, 908	Cast iron	128mm c.c.	149 x 39mm	5 7/8" x 1 17/32" M4
5	388538	FB, 132, 908	Cast iron	Ø 38mm	38 x 37mm	1 1/2" x 1 7/16" M4
6	388532	FB, 132, 908	Cast iron	Ø 32mm	32 x 35mm	1 1/4" x 1 3/8" M4



BORB



REF. NO.	COLOR FINISH	MATERIAL DESCRIPTION	DIMENSION C.C. / Ø	OVERALL DIMENSION (L x P) METRIC	OVERALL DIMENSION (L x P) IMPERIAL	SCREW NAIL
1	392112 BORB, 180, 195	Metal	12" c.c.	335 x 69mm	13 3/16" x 2 11/16"	M6
2	392108 BORB, 180, 195	Metal	8" c.c.	228 x 54mm	9" x 2 1/8"	M6
3	3921160 BORB, 180, 195	Metal	160mm c.c.	174 x 34mm	6 7/8" x 1 5/16"	M4

REF. NO.	COLOR FINISH	MATERIAL DESCRIPTION	DIMENSION C.C. / Ø	OVERALL DIMENSION (L x P) METRIC	OVERALL DIMENSION (L x P) IMPERIAL	SCREW NAIL
4	3921128 BORB, 180, 195	Metal	128mm c.c.	142 x 34mm	5 9/16" x 1 5/16"	M4
5	392134 BORB, 180, 195	Metal	34 x 34mm	34 x 23mm	1 5/16" x 7/8"	M4



REF. NO.	COLOR FINISH	MATERIAL DESCRIPTION	DIMENSION C.C. / Ø	OVERALL DIMENSION METRIC	OVERALL DIMENSION (L x P) IMPERIAL	SCREW NAIL
1	502112 BORB, 180, 195	Metal	12" c.c.	332 x 56mm	13 1/16" x 2 3/16"	M6
2	502108 BORB, 180, 195	Metal	8" c.c.	231 x 56mm	9 1/16" x 2 3/16"	M6
3	502106 BORB, 180, 195	Metal	6" c.c.	172 x 40mm	6 3/4" x 1 9/16"	M4

REF. NO.	COLOR FINISH	MATERIAL DESCRIPTION	DIMENSION C.C. / Ø	OVERALL DIMENSION METRIC	OVERALL DIMENSION (L x P) IMPERIAL	SCREW NAIL
4	502104 BORB, 180, 195	Metal	4" c.c.	121 x 38mm	4 3/4" x 1 1/2"	M4
5	501238 BORB, 180, 195	Metal	38 x 38mm	38 x 35mm	1 1/2" x 1 3/8"	M4
6	501232 BORB, 180, 195	Metal	32 x 32mm	32 x 30mm	1 1/4" x 1 3/16"	M4



# BRONZE COLLECTION

These massive bronze products are suitable with different traditional styles of indoor or outdoor architecture while featuring a classical elegance and robustness.



REF. NO.	COLOR FINISH	MATERIAL DESCRIPTION	DIMENSION C.C. / Ø	OVERALL DIMENSION (L x P) METRIC	OVERALL DIMENSION (L x P) IMPERIAL	SCREW NAIL
1	6328812 DB, PB	Bronze	12"	350 x 87mm	13 25/32" x 3 7/16"	5/16
2	632884 DB, PB	Bronze	4"	135 x 42mm	5 5/16" x 1 21/32"	8/32
3	8417712 DB, PB	Bronze	12"	342 x 54mm	13 15/32" x 2 1/8"	8/32
4	841774 DB, PB	Bronze	3"	127 x 35mm	5" x 1 3/8"	8/32

REF. NO.	COLOR FINISH	MATERIAL DESCRIPTION	DIMENSION C.C. / Ø	OVERALL DIMENSION (L x P) METRIC	OVERALL DIMENSION (L x P) IMPERIAL	SCREW NAIL
5	19952 DB, PB	Bronze	52mm	52 x 50mm	2 1/16" x 1 31/32"	8/32
6	19942 DB, PB	Bronze	42mm	42 x 40mm	1 21/32" x 1 9/16"	8/32
7	19935 DB, PB	Bronze	35mm	35 x 33mm	1 3/8" x 1 5/16"	8/32
8	19928 DB, PB	Bronze	28mm	28 x 32mm	1 3/32" x 1 1/4"	8/32



REF. NO.	COLOR FINISH	MATERIAL DESCRIPTION	DIMENSION C.C. / Ø	OVERALL DIMENSION (L x P) METRIC	OVERALL DIMENSION (L x P) IMPERIAL	SCREW NAIL
1	DB, PB	Bronze	12"	335 x 77mm	13 5/32" x 3"	5/16
2	DB, PB	Bronze	10"	290 x 75mm	11 3/8" x 2 15/16"	5/16
3	DB, PB	Bronze	4"	112 x 24mm	4 13/32" x 1 5/16"	Wood screw
4	DB, PB	Bronze	50mm	50 x 35mm	1 31/32" x 1 3/8"	8/32
5	DB, PB	Bronze	40mm	40 x 30mm	1 9/16" x 1 3/16"	8/32

REF. NO.	COLOR FINISH	MATERIAL DESCRIPTION	DIMENSION C.C. / Ø	OVERALL DIMENSION (L x P) METRIC	OVERALL DIMENSION (L x P) IMPERIAL	SCREW NAIL
6	DB, PB	Bronze	38mm	38 x 25mm	1 1/2" x 1"	8/32
7	DB, PB	Bronze	40mm	40 x 33mm	1 9/16" x 1 5/16"	8/32
8	DB, PB	Bronze	30mm	30 x 25mm	1 3/16" x 1"	8/32
9	DB, PB	Bronze	30 x 30mm	30 x 29mm	1 3/16" x 1 5/32"	8/32



# FORGED IRON AND LIMOGES PORCELAIN

Inspired by the medieval fashion that makes it a fascinating age comes forged iron. We are offering you a route through our heritage where forged iron and brass are changing functional and decorative hardware.



REF. NO.	COLOR FINISH	MATERIAL DESCRIPTION	DIMENSION C.C. / Ø	OVERALL DIMENSION (L x P/H) METRIC	OVERALL DIMENSION (L x P/H) IMPERIAL	SCREW NAIL
1	202192 800, 900, 908	Forged iron	92mm c.c.	108 x 20mm	4 1/4" x 25/32"	Wood screw
2	223018 800, 900, 908	Forged iron	180mm c.c.	209 x 46mm	8 7/32" x 1 13/16"	M4
3	223012 800, 900, 908	Forged iron	120mm c.c.	145 x 40mm	5 23/32" x 1 9/16"	M4
4	13535 908/ 30, 332	F.I. & Limoges porc.	Ø 35mm	35 x 36mm	1 3/8" x 1 13/32"	M4
5	13030 908/ 30, 332	F.I. & Limoges porc.	Ø 30mm	30 x 34mm	1 3/16" x 1 11/32"	M4
6	94018 908/ 30, 332	F.I. & Limoges porc.	180mm c.c.	209 x 46mm	8 7/32" x 1 13/16"	M4
7	93012 908/ 30, 332	F.I. & Limoges porc.	120mm c.c.	145 x 40mm	5 23/32" x 1 9/16"	M4
8	13535 800/ 30, 332	F.I. & Limoges porc.	Ø 35mm	35 x 36mm	1 3/8" x 1 13/32"	M4
9	13030 800/ 30, 332	F.I. & Limoges porc.	Ø 30mm	30 x 34mm	1 3/16" x 1 11/32"	M4
10	94018 800/ 30, 332	F.I. & Limoges porc.	180mm c.c.	209 x 46mm	8 7/32" x 1 13/16"	M4

REF. NO.	COLOR FINISH	MATERIAL DESCRIPTION	DIMENSION C.C. / Ø	OVERALL DIMENSION (L/W x P/H) METRIC	OVERALL DIMENSION (L/W x P/H) IMPERIAL	SCREW NAIL
11	93012 800/ 30, 332	F.I. & Limoges porc.	120mm c.c.	145 x 40mm	5 23/32" x 1 9/16"	M4
12	90046 908/ 30	F.I. & Limoges porc.	30 x 61mm	30 x 61mm	1 3/16" x 2 13/32"	M4
13	90046 800/ 30	F.I. & Limoges porc.	30 x 61mm	30 x 61mm	1 3/16" x 2 13/32"	M4
14	260735 800, 900, 908	Forged iron	Ø 35mm	35 x 35mm	1 3/8" x 1 3/8"	M4
15	213635 800, 900, 908	Forged iron rosette	35 x 35mm	35 x 35mm	1 3/8" x 1 3/8"	M4
16	260730 800, 900, 908	Forged iron	Ø 30mm	30 x 30mm	1 3/16" x 1 3/16"	M4
17	213630 800, 900, 908	Forged iron rosette	30 x 30mm	30 x 30mm	1 3/16" x 1 3/16"	M4
18	260720 800, 900, 908	Forged iron	Ø 20mm	20 x 20mm	25/32" x 25/32"	M4
19	213620 800, 900, 908	Forged iron rosette	20 x 20mm	20 x 20mm	25/32" x 25/32"	M4

Legend: F.I. = Forged iron Porc. = Porcelain Nails and screws: see p.121



REF. NO.	COLOR FINISH	MATERIAL DESCRIPTION	DIMENSION C.C. / Ø	OVERALL DIMENSION (L/W x P/H) METRIC	OVERALL DIMENSION (L/W x P/H) IMPERIAL	SCREW NAIL
1	220185	800, 900, 908 Forged iron	87mm c.c.	117 x 30mm	4 19/32" x 1 3/16"	M4
2	221911	800, 900, 908 Forged iron	115mm c.c.	123 x 35mm	4 27/32" x 1 3/8"	M4
3	130930	800, 900, 908 Forged iron		85 x 30mm	3 11/32" x 1 3/16"	M5
4	220485	800, 900, 908 Forged iron	87mm c.c.	117 x 30mm	4 19/32" x 1 3/16"	M4
5	220513	800, 900, 908 Forged iron	120mm c.c.	150 x 50mm	5 29/32" x 1 31/32"	M4
6	261030	800, 900, 908 Forged iron	Ø 30mm	45 x 30mm	1 25/32" x 1 3/16"	M4
7	240240	800, 900, 908 Forged iron	Ø 40mm	40 x 17mm	1 9/16" x 21/32"	M4
8	240230	800, 900, 908 Forged iron	Ø 30mm	30 x 17mm	1 3/16" x 21/32"	M4

REF. NO.	COLOR FINISH	MATERIAL DESCRIPTION	DIMENSION C.C. / Ø	OVERALL DIMENSION (L/W x P/H) METRIC	OVERALL DIMENSION (L/W x P/H) IMPERIAL	SCREW NAIL
9	240440	800, 900, 908 Forged iron	Ø 40mm	40 x 17mm	1 9/16" x 21/32"	M4
10	240430	800, 900, 908 Forged iron	Ø 30mm	30 x 17mm	1 3/16" x 21/32"	M4
11	260918	800, 900, 908 Forged iron		55 x 29mm	2 5/32" x 1 5/32"	M4
12	20509	800, 900, 908 Forged iron		30 x 75mm	1 3/16" x 2 15/16"	M4
13	30202	800, 900, 908 Forged iron shelf support		320 x 290mm	12 19/32" x 11 13/32"	Wood screw
14	30401	800, 900, 908 Forged iron hook		105 x 98mm	4 1/8" x 3 27/32"	Wood screw
15	30301	800, 900, 908 Forged iron hook		105 x 250mm	4 1/8" x 9 27/32"	Wood screw

Nails and screws: see p.121





REF. NO.	COLOR FINISH	MATERIAL DESCRIPTION	DIMENSION C.C. / Ø	OVERALL DIMENSION (L x P) METRIC	OVERALL DIMENSION (L x P) IMPERIAL	SCREW NAIL
1	15133 BB, 163, 190, 904	Brass	64mm c.c.	95 x 49mm	3 3/4" x 1 15/16"	M4
2	6440 AE, 130, 195, 903	Metal	64mm c.c.	96 x 38mm	3 25/32" x 1 1/2"	M4
3	1512188 BB, 130, 163, 904	Brass	32mm c.c.	88 x 44mm	3 15/32" x 1 23/32"	M4
4	33332 163, 904	Brass	32mm c.c.	81 x 53mm	3 3/16" x 2 3/32"	M4

REF. NO.	COLOR FINISH	MATERIAL DESCRIPTION	DIMENSION C.C. / Ø	OVERALL DIMENSION (L x P) METRIC	OVERALL DIMENSION (L x P) IMPERIAL	SCREW NAIL
5	33232 163, 904	Brass	32mm c.c.	97 x 35mm	3 13/16" x 1 3/8"	M4
6	1512296 BB, 130, 163, 904	Brass	96 x 37mm	96 x 37mm	3 25/32" x 1 15/32"	135140-xx
7	45124 BB, 163, 193, 904, 911	Brass	72 x 34mm	72 x 34mm	2 27/32" x 1 11/32"	135140-xx

Nails and screws: see p.121



REF. NO.	COLOR FINISH	MATERIAL DESCRIPTION	DIMENSION C.C. / Ø	OVERALL DIMENSION (L x P)		SCREW NAIL
				METRIC	IMPERIAL	
1	BB, 163, 164, 904	Brass		67 x 53mm	2 5/8" x 2 3/32"	M4
2	BB, 163, 164	Brass		35 x 47mm	1 3/8" x 1 27/32"	M4
3	BB, 163, 164, 904	Brass		22 x 68mm	7/8" x 2 11/16"	M4
4	BB, 163, 164, 904	Brass		18 x 51mm	23/32" x 2"	M4
5	BB, 130	Brass	64mm c.c	84 x 33mm	3 5/16" x 1 5/16"	M4
6	163, 904	Brass	Ø 25mm	25 x 20mm	1" x 25/32"	M4
7	130, 163, 904	Brass	Ø 25mm	90 x 25mm	3 17/32" x 1"	M4 & 135140-xx
8	BB, 163, 164, 904	Brass	Ø 40mm	40 x 46mm	1 9/16" x 1 13/16"	M4

REF. NO.	COLOR FINISH	MATERIAL DESCRIPTION	DIMENSION C.C. / Ø	OVERALL DIMENSION (L x P)		SCREW NAIL
				METRIC	IMPERIAL	
9	BB, 163, 164, 904	Brass	Ø 33mm	33 x 39mm	1 5/16" x 1 17/32"	M4
10	AE, 130, 142	Brass	Ø 30mm	30 x 25mm	1 3/16" x 1"	8/32
11	AE, 130, 142	Brass	Ø 25mm	25 x 25mm	1" x 1"	8/32
12	AE, 130, 142	Brass	Ø 30mm	30 x 25mm	1 3/16" x 1"	8/32
13	AE, 130, 142	Brass	Ø 25mm	25 x 25mm	1" x 1"	8/32
14	AE, 130, 142	Brass	Ø 30mm	30 x 25mm	1 3/16" x 1"	8/32
15	AE, 130, 142	Brass	Ø 25mm	25 x 25mm	1" x 1"	8/32
16	AE, 130	Brass	Ø 25mm	25 x 25mm	1" x 1"	8/32

Nails and screws: see p.121







REF. NO.	COLOR FINISH	MATERIAL DESCRIPTION	DIMENSION C.C. / Ø	OVERALL DIMENSION (L x P/H) METRIC	OVERALL DIMENSION (L x P/H) IMPERIAL	SCREW NAIL
1	308596 BB, 130	Solid brass	96mm c.c.	123 x 50mm	4 27/32" x 1 31/32"	M4
2	308564 BB, 130	Solid brass	64mm c.c.	86 x 33mm	3 3/8" x 1 5/16"	M4
3	3004108 BB, 130	Solid brass	108mm c.c.	128 x 51mm	5 1/32" x 2"	M4
4	300473 BB, 130	Solid brass	73mm c.c.	93 x 38mm	3 21/32" x 1 1/2"	M4
5	151996 BB, 130	Solid brass	96mm c.c.	158 x 34mm	6 7/32" x 1 11/32"	M4

REF. NO.	COLOR FINISH	MATERIAL DESCRIPTION	DIMENSION C.C. / Ø	OVERALL DIMENSION (L/W x P/H) METRIC	OVERALL DIMENSION (L/W x P/H) IMPERIAL	SCREW NAIL
6	151964 BB, 130	Solid brass	64mm c.c.	99 x 22mm	3 29/32" x 7/8"	M4
7	2223124 BB, 130	Solid brass		22 x 124mm	7/8" x 4 7/8"	M4 & 135140-xxx
8	3772545 BB, 130	Solid brass		31 x 58mm	1 7/32" x 2 9/32"	M4
9	3772458 BB, 130	Solid brass		33 x 58mm	1 5/16" x 2 9/32"	M4
10	3772641 BB, 130	Solid brass		24 x 50mm	15/16" x 1 31/32"	M4

Nails and screws: see p.121



REF. NO.	COLOR FINISH	MATERIAL DESCRIPTION	DIMENSION C.C. / Ø	OVERALL DIMENSION (L x P) METRIC	OVERALL DIMENSION (L x P) IMPERIAL	SCREW NAIL
1	2447918	BB, 130 Brass	Ø 18mm	18 x 16mm	23/32" x 5/8"	M4
2	2447926	BB, 130 Brass	Ø 26mm	26 x 19mm	1 1/32" x 3/4"	M4
3	2447931	BB, 130 Brass	Ø 31mm	31 x 21mm	1 7/32" x 13/16"	M4
4	2447936	BB, 130 Brass	Ø 36mm	36 x 24mm	1 13/32" x 15/16"	M4
5	2440535	BB, 130 Brass	Ø 35mm	35 x 25mm	1 3/8" x 1"	M4
6	2440530	BB, 130 Brass	Ø 30mm	30 x 20mm	1 3/16" x 25/32"	M4
7	2440525	BB, 130 Brass	Ø 25mm	25 x 17mm	1" x 21/32"	M4
8	2440520	BB, 130 Brass	Ø 20mm	20 x 16mm	25/32" x 5/8"	M4
9	2440425	BB, 130 Brass	Ø 25mm	25 x 21mm	1" x 13/16"	M4
10	2440430	BB, 130 Brass	Ø 30mm	30 x 23mm	1 3/16" x 29/32"	M4
11	2440435	BB, 130 Brass	Ø 35mm	35 x 25mm	1 3/8" x 1"	M4

REF. NO.	COLOR FINISH	MATERIAL DESCRIPTION	DIMENSION C.C. / Ø	OVERALL DIMENSION (L/W x P/H) METRIC	OVERALL DIMENSION (L/W x P/H) IMPERIAL	SCREW NAIL
12	2440135	BB, 130, 164 Brass	Ø 35mm	35 x 29mm	1 3/8" x 1 5/32"	M4
13	2440130	BB, 130, 164 Brass	Ø 30mm	30 x 24mm	1 3/16" x 15/16"	M4
14	2440125	BB, 130, 164 Brass	Ø 25mm	25 x 23mm	1" x 29/32"	M4
15	3004108	130 Brass	108mm c.c.	128 x 51mm	5 1/32" x 2"	M4
16	3772458	130 Solid brass		33 x 58mm	1 5/16" x 2 9/32"	M4
17	3572446	130 Solid brass Mock key		33 x 47mm	1 5/16" x 1 27/32"	M4
18	30639131.2 right 30639131.3 left	130 Solid brass Keyhole plate		23 x 131mm	29/32" x 5 5/32"	135140-xxx
19	8416.02 right 8416.03 left	130 Solid brass Hinge	Blade 60 x 40mm	90mm	3 17/32"	Wood screw

Nails and screws: see p.121



REF. NO.	COLOR FINISH	MATERIAL DESCRIPTION	DIMENSION C.C. / Ø	OVERALL DIMENSION METRIC	OVERALL DIMENSION (L x P) IMPERIAL	SCREW NAIL	
1	2448735	BB, 130, 163, 164, 904	Brass	Ø 35mm	35 x 31mm	1 3/8" x 1 7/32"	M4
2	2448730	BB, 130, 163, 164, 904	Brass	Ø 30mm	30 x 27mm	1 3/16" x 1 1/16"	M4
3	2448725	BB, 130, 163, 164, 904	Brass	Ø 25mm	25 x 25mm	1" x 1"	M4
4	2440835	BB, 130, 163, 164, 904	Brass	Ø 35mm	35 x 30mm	1 3/8" x 1 3/16"	M4
5	2440830	BB, 130, 163, 164, 904	Brass	Ø 30mm	30 x 26mm	1 3/16" x 1 1/32"	M4
6	2440825	BB, 130, 163, 164, 904	Brass	Ø 25mm	25 x 23mm	1" x 29/32"	M4
7	2449935	BB, 130, 163, 164, 904	Brass	Ø 35mm	35 x 30mm	1 3/8" x 1 3/16"	M4
8	2449930	BB, 130, 163, 164, 904	Brass	Ø 30mm	30 x 26mm	1 3/16" x 1 1/32"	M4

REF. NO.	COLOR FINISH	MATERIAL DESCRIPTION	DIMENSION C.C. / Ø	OVERALL DIMENSION METRIC	OVERALL DIMENSION (L/W x P/H) IMPERIAL	SCREW NAIL	
9	2449925	BB, 130, 163, 164, 904	Brass	Ø 25mm	25 x 23mm	1" x 29/32"	M4
10	308764	BB	Solid brass Drop handle	64mm c.c.	82 x 32mm	3 7/32" x 1 1/4"	M4
11	306357	BB	Solid brass Keyhole plate	20 x 57mm	25/32" x 2 1/4"	135140-xxx	
12	8312	AE	Metal mock key	31 x 35mm	1 7/32" x 1 3/8"	M4	
13	21009	BB	Solid brass Pivot hinge	Ø 8mm	90mm	3 17/32"	Wood screw

Nails and screws: see p.121



REF. NO.	COLOR FINISH	MATERIAL DESCRIPTION	DIMENSION C.C. / Ø	OVERALL DIMENSION (L x P) METRIC	OVERALL DIMENSION (L x P) IMPERIAL	SCREW NAIL	
1	2266	134, 142/190	Metal	96mm c.c.	119 x 23mm	4 11/16" x 29/32"	M4
2	4549	134, 142/190	Metal plate		147 x 31mm	5 25/32" x 1 7/32"	
3	781196	134, 142	Metal	96mm c.c.	126 x 25mm	4 32/32" x 1"	M4
4	2996	134, 142/190	Metal	Ø 38mm	38 x 21mm	1 1/2" x 13/16"	M4
5	12323	167, 904	Brass		32 x 55mm	1 1/4" x 2 5/32"	M4
6	12233	167, 904	Brass		33 x 97mm	1 5/16" x 3 13/16"	M4
7	6323109	163, 904	Brass	64mm c.c.	108 x 38mm	4 1/4" x 1 1/2"	M4
8	06323	167, 904	Brass	64mm c.c.	97 x 33mm	3 13/16" x 1 5/16"	M4

REF. NO.	COLOR FINISH	MATERIAL DESCRIPTION	DIMENSION C.C. / Ø	OVERALL DIMENSION (L x P) METRIC	OVERALL DIMENSION (L x P) IMPERIAL	SCREW NAIL	
9	06325	163	Brass	96mm c.c.	105 x 19mm	4 1/8" x 3/4"	M4
10	8150	134, 142	Metal	Ø 25mm	25 x 19mm	1" x 3/4"	M4
11	8208	134, 142	Metal plate		20 x 79mm	13/16" x 3 1/8"	285-xx
12	80074	142	Metal	96mm c.c.	126 x 32mm	4 31/32" x 1 1/4"	M4
13	829536	134, 142	Metal	Ø 36mm	36 x 22mm	1 13/32" x 7/8"	M4
14	829430	134, 142	Metal	Ø 30mm	30 x 20mm	1 3/16" x 25/32"	M4
15	844396	134, 142	Metal	96mm c.c.	110 x 25mm	4 11/32" x 1"	M4

Nails and screws: see p.121





REF. NO.	COLOR FINISH	MATERIAL DESCRIPTION	DIMENSION C.C. / Ø	OVERALL DIMENSION (L x P) METRIC	OVERALL DIMENSION (L x P) IMPERIAL	SCREW NAIL
1	69864 138, 139, 900	Metal	64mm c.c.	75 x 19mm	2 15/16" x 3/4"	M4
2	69896 138, 139, 900	Metal	96mm c.c.	107 x 20mm	4 7/32" x 25/32"	M4
3	60996 138, 139, 900	Metal	96mm c.c.	110 x 24mm	4 11/32" x 15/16"	M4
4	61655696 138, 139, 195	Metal	96mm c.c.	117 x 22mm	7/8" x 4 19/32"	M4
5	61612595 128, 138, 139, 164	Metal		23 x 95mm	29/32" x 3 3/4"	M4

REF. NO.	COLOR FINISH	MATERIAL DESCRIPTION	DIMENSION C.C. / Ø	OVERALL DIMENSION (L x P) METRIC	OVERALL DIMENSION (L x P) IMPERIAL	SCREW NAIL
6	7630 135, 195	Metal	Ø 30mm	30 x 23mm	1 3/16" x 29/32"	M4
7	43996 128, 164, 195, 903	Metal	96mm c.c.	109 x 25mm	4 9/32" x 1"	M4
8	16930 128, 164, 195, 903	Metal	Ø 30mm	30 x 23mm	1 3/16" x 29/32"	M4
9	53864 903	Metal	64mm c.c.	75 x 19mm	2 15/16" x 3/4"	M4
10	53896 164, 195, 903	Metal	96mm c.c.	108 x 24mm	4 1/4" x 15/16"	M4



REF. NO.	COLOR FINISH	MATERIAL DESCRIPTION	DIMENSION C.C. / Ø	OVERALL DIMENSION (L x P) METRIC	OVERALL DIMENSION (L x P) IMPERIAL	SCREW NAIL
1	138, 139	Metal	160mm c.c.	178 x 26mm	7" x 1 1/32"	M4
2	138, 139, 195	Metal	64mm c.c.	83 x 41mm	3 9/32" x 1 5/8"	M4
3	138, 139	Metal	64mm c.c.	78 x 21mm	3 1/16" x 13/16"	M4
4	138, 139	Metal	96mm c.c.	120 x 23mm	4 23/32" x 29/32"	M4
5	138, 139	Metal		30 x 27mm	1 3/16" x 1 3/32"	M4
6	138, 139	Metal	96mm c.c.	112 x 23mm	4 13/32" x 29/32"	M4
7	433 138	Metal	96mm c.c.	119 x 19mm	4 11/16" x 3/4"	M4
8	63896	Metal	96mm c.c.	121 x 23mm	4 3/4" x 29/32"	M4

REF. NO.	COLOR FINISH	MATERIAL DESCRIPTION	DIMENSION C.C. / Ø	OVERALL DIMENSION (L x P) METRIC	OVERALL DIMENSION (L x P) IMPERIAL	SCREW NAIL
9	17970	138	Metal	22 x 70mm	7/8" x 2 3/4"	M4
10	61657496	138, 139	Metal	96mm c.c.	121 x 23mm 29/32" x 4 3/4"	M4
11	16930	138, 139	Metal	Ø 30mm	30 x 24mm 1 3/16" x 15/16"	M4
12	20630	138, 139	Metal	Ø 30mm	30 x 25mm 1 3/16" x 1"	M4
13	30827	138, 139	Metal	Ø 27mm	27 x 20mm 1 1/16" x 25/32"	M4
14	15457	138, 139	Metal	18 x 57mm	23/32" x 2 1/4"	M4
15	55542	138	Metal	42 x 42mm	1 21/32" x 1 21/32"	M4
16	48332	138	Metal	32mm c.c.	63 x 60mm 2 1/2" x 2 3/8"	M4



REF. NO.	COLOR FINISH	MATERIAL DESCRIPTION	DIMENSION Ø INSIDE	OVERALL DIMENSION METRIC	OVERALL DIMENSION (L x H) IMPERIAL	SCREW NAIL
1	95457 130	Brass ring	Ø 57mm	75 x 46mm	2 15/16" x 1 13/16"	Nail
	95450 130	Brass ring	Ø 50mm	67 x 45mm	2 5/8" x 1 25/32"	Nail
	95440 130	Brass ring	Ø 40mm	55 x 44mm	2 5/32" x 1 23/32"	Nail
2	95557 130	Brass half ring	Ø 57mm	75 x 46mm	2 15/16" x 1 13/16"	Nail
	95550 130	Brass half ring	Ø 50mm	67 x 45mm	2 5/8" x 1 25/32"	Nail
	95540 130	Brass half ring	Ø 40mm	55 x 44mm	2 5/32" x 1 23/32"	Nail
3	957510 130, 168	Brass ring	Ø 51mm	67 x 49mm	2 5/8" x 1 15/16"	Nail
	957450 130, 163, 168	Brass ring	Ø 45mm	61 x 47mm	2 13/32" x 1 27/32"	Nail
	957380 130, 163, 168	Brass ring	Ø 38mm	54 x 42mm	2 1/8" x 1 21/32"	Nail
4	957511 130, 163, 168	Brass ring	Ø 51mm	67 x 28mm	2 5/8" x 1 3/32"	Nail
	957451 130, 163	Brass ring	Ø 45mm	61 x 26mm	2 13/32" x 1 11/32"	Nail
	957381 163, 168	Brass ring	Ø 38mm	54 x 26mm	2 1/8" x 1 1/32"	Nail
5	959510 130, 163, 168	Brass half ring	Ø 51mm	67 x 49mm	2 5/8" x 1 15/16"	Nail
	959450 130, 163, 168	Brass half ring	Ø 45mm	61 x 47mm	2 13/32" x 1 27/32"	Nail
	959380 130, 163	Brass half ring	Ø 38mm	54 x 42mm	2 1/8" x 1 21/32"	Nail

REF. NO.	COLOR FINISH	MATERIAL DESCRIPTION	DIMENSION Ø INSIDE	OVERALL DIMENSION METRIC	OVERALL DIMENSION (L x H) IMPERIAL	SCREW NAIL
6	959511 130, 163, 168	Brass half ring	Ø 51mm	67 x 28mm	2 5/8" x 1 3/32"	Nail
	959451 130, 163, 168	Brass half ring	Ø 45mm	61 x 26mm	2 13/32" x 1 11/32"	Nail
	959381 130, 163, 168	Brass half ring	Ø 38mm	54 x 26mm	2 1/8" x 1 1/32"	Nail

REF. NO.	COLOR FINISH	MATERIAL DESCRIPTION	OPENING	OVERALL DIMENSION METRIC	OVERALL DIMENSION (L x H x P) IMPERIAL	SCREW NAIL
7	101530 130, 135	Brass tip	30 x 30mm	35mm (H)	1 3/8" (H)	
8	101525 130, 135	Brass tip	25 x 25mm	30mm (H)	1 3/16" (H)	
9	98201 130	Brass column ornament		80 x 51 x 38mm	3 5/32" x 2" x 1 1/2"	Nail
10	98202 130	Brass column ornament		69 x 47 x 29mm	2 23/32" x 1 27/32" x 1 5/32"	Nail
11	98203 130	Brass column ornament		48 x 44 x 22mm	1 7/8" x 1 23/32" x 7/8"	Nail

Nail and screws: see p. 121



REF. NO.	COLOR FINISH	MATERIAL DESCRIPTION	DIMENSION C.C. / Ø	OVERALL DIMENSION (L x P) METRIC	OVERALL DIMENSION (L x P) IMPERIAL	SCREW NAIL
1	2445935 BB, 130, 163, 164, 904	Solid brass	Ø 35mm	35 x 22mm	1 3/8" x 7/8"	M4
2	2445930 BB, 130, 163, 164, 904	Solid brass	Ø 30mm	30 x 20mm	1 3/16" x 25/32"	M4
3	2445925 BB, 130, 163, 164, 904	Solid brass	Ø 25mm	25 x 19mm	1" x 3/4"	M4
4	2445920 BB, 130, 163, 164, 904	Solid brass	Ø 20mm	20 x 15mm	25/32" x 19/32"	M4
5	2445913 BB, 130, 163, 164, 904	Solid brass	Ø 13mm	13 x 10mm	1/2" x 13/32"	M4
6	2449225 BB, 130	Brass	Ø 25mm	25 x 21mm	1" x 13/16"	M4
7	2449230 BB, 130	Brass	Ø 30mm	30 x 24mm	1 3/16" x 15/16"	M4
8	2449235 BB, 130	Brass	Ø 35mm	35 x 28mm	1 3/8" x 1 1/4"	M4
9	24463 BB, 130, 163, 904	Solid brass	35 x 21mm	35 x 20mm	1 3/8" x 25/32"	M4

REF. NO.	COLOR FINISH	MATERIAL DESCRIPTION	DIMENSION C.C. / Ø	OVERALL DIMENSION (L/W x P/H) METRIC	OVERALL DIMENSION (L/W x P/H) IMPERIAL	SCREW NAIL
10	3035110 163	Solid brass	110mm c.c.	129 x 43mm	5 3/32" x 1 11/16"	M4
11	303580 163	Solid brass	80mm c.c.	98 x 34mm	3 27/32" x 1 11/32"	M4
12	35728 163	Solid brass Mock key		29 x 38mm	1 5/32" x 1 1/2"	M4
13	3069347 163	Solid brass Keyhole plate		24 x 47mm	15/16" x 1 27/32"	135140-xxx

Nails and screws: see p.121







REF. NO.	COLOR FINISH	MATERIAL DESCRIPTION	DIMENSION C.C. / Ø	OVERALL DIMENSION (L x P)		SCREW NAIL	REF. NO.	COLOR FINISH	MATERIAL DESCRIPTION	DIMENSION C.C. / Ø	OVERALL DIMENSION (L x P)		SCREW NAIL		
				METRIC	IMPERIAL						METRIC	IMPERIAL			
1	2414732	209, 222, 904	Brass	32mm c.c.	73 x 25mm	2 7/8" x 1"	M4	5	15134128	209, 904	Brass/enamel	128mm c.c.	141 x 29mm	5 9/16" x 1 1/8"	M4
2	15147128	209, 222, 904	Brass	128mm c.c.	190 x 30mm	7 15/32" x 1 3/16"	M4	6	2413432	209, 904	Brass/enamel	32mm c.c.	73 x 25mm	2 27/8" x 1"	M4
3	1514064	209, 222, 904	Brass	64mm c.c.	104 x 27mm	4 1/8" x 1 1/16"	M4	7	3413030	209, 904	Brass/enamel	Ø 30mm	30 x 22mm	1 3/16" x 7/8"	M4
4	1513064	209, 904	Brass/enamel	64mm c.c.	104 x 27mm	4 1/8" x 1 1/16"	M4								

# ZEN GARDEN



REF. NO.	COLOR FINISH	MATERIAL DESCRIPTION	DIMENSION C.C. / Ø	OVERALL DIMENSION (L x P) METRIC	OVERALL DIMENSION (L x P) IMPERIAL	SCREW NAIL
1	15037128	209, 222	Brass	128mm c.c.	160 x 24mm 6 5/16" x 15/16"	M4
2	1503796	209, 222	Brass	96mm c.c.	120 x 22mm 4 23/32" x 7/8"	M4
3	2403724	209, 222	Brass	24 x 19mm	15/16" x 3/4"	M4

REF. NO.	COLOR FINISH	MATERIAL DESCRIPTION	DIMENSION C.C. / Ø	OVERALL DIMENSION (L/Ø x P) METRIC	OVERALL DIMENSION (L/Ø x P) IMPERIAL	SCREW NAIL
4	45037168	209, 222	Brass	64mm c.c.	Ø168 x 22mm Ø 6 5/8" x 15/16"	M4
5	1513796	163, 904, 911	Brass	96mm c.c.	118 x 23mm 4 21/32" x 29/32"	M4
6	2556841	163, 904, 911	Brass	25 x 41mm	1" x 1 5/8"	M4 & 135140-xxx

Nails and screws: see p.121



REF. NO.	COLOR FINISH	MATERIAL DESCRIPTION	DIMENSION C.C. / Ø	OVERALL DIMENSION (L x P) METRIC	OVERALL DIMENSION (L x P) IMPERIAL	SCREW NAIL
1	15130128 BB, 163, 904, 911	Brass	128mm c.c.	138 x 30mm	5 7/16" x 1 3/16"	M4
2	1513096 BB, 163, 190, 904, 911	Brass	96mm c.c.	105 x 30mm	4 1/8" x 1 3/16"	M4
3	2413030 BB, 163, 190, 904, 911	Brass	Ø 30mm	30 x 23mm	1 3/16" x 29/32"	M4
4	570160 138, 139, 148, 167, 195	Brass	160mm c.c.	180 x 32mm	7 1/16" x 1 1/4"	M4
5	2565595 BB, 163, 904, 911	Brass		95 x 29mm	3 3/4" x 1 5/32"	M4

REF. NO.	COLOR FINISH	MATERIAL DESCRIPTION	DIMENSION C.C. / Ø	OVERALL DIMENSION (L x P) METRIC	OVERALL DIMENSION (L x P) IMPERIAL	SCREW NAIL	
6	613433 138, 139, 148, 167, 195	Brass	Ø 33mm	33 x 28mm	1 5/16" x 1 3/32"	M4	
7	49496 138, 139, 148, 167, 195	Brass		96mm c.c.	107 x 29mm	4 3/16" x 1 1/8"	M4
8	8651 142	Metal	Ø 35mm	35 x 31mm	1 3/8" x 1 7/32"	M4	
9	8652 142	Metal	Ø 30mm	30 x 27mm	1 3/16" x 1 1/16"	M4	



REF. NO.	COLOR FINISH	MATERIAL DESCRIPTION	DIMENSION C.C. / Ø	OVERALL DIMENSION (L x P)		SCREW NAIL
				METRIC	IMPERIAL	
1	5086128 140, 222, 904	Metal	128mm c.c.	159 x 31mm	6 1/4" x 1 3/16"	M4
2	5086035 140, 222, 904	Metal		34 x 20mm	1 5/16" x 3/4"	M4
3	5057128 140, 222, 904	Metal	128mm c.c.	183 x 29mm	7 3/16" x 1 1/8"	M4
4	5057064 140, 222, 904	Metal	64mm c.c.	98 x 26mm	3 7/8" x 1"	M4

REF. NO.	COLOR FINISH	MATERIAL DESCRIPTION	DIMENSION C.C. / Ø	OVERALL DIMENSION (L x P)		SCREW NAIL
				METRIC	IMPERIAL	
5	5083047 140, 222, 904	Metal		47 x 24mm	1 13/16" x 15/16"	M4
6	5083128 140, 222, 904	Metal	128mm c.c.	149 x 29mm	5 13/16" x 1 1/8"	M4
7	5083096 140, 222, 904	Metal	96mm c.c.	113 x 27mm	4 7/16" x 1 1/16"	M4



REF. NO.	COLOR FINISH	MATERIAL DESCRIPTION	DIMENSION C.C.	OVERALL DIMENSION (L x P) METRIC	OVERALL DIMENSION (L x P) IMPERIAL	SCREW	
1	159096	140, 222, 904	Metal	96mm	134 x 22mm	5 1/4" x 7/8"	M4
2	159160	140, 222, 904	Metal	160mm	200 x 22mm	7 7/8" x 7/8"	M4
3	160128	140, 222, 904	Metal	128mm	150 x 22mm	5 7/8" x 7/8"	M4
4	161064	140, 222, 904	Metal	64mm	Ø 83 x 22mm	Ø 3 1/4" x 7/8"	M4
5	161128	140, 222, 904	Metal	128mm	151 x 22mm	5 15/16" x 7/8"	M4
6	160064	140, 222, 904	Metal	64mm	87 x 22mm	3 7/16" x 7/8"	M4
7	160032	140, 222, 904	Metal	32mm	48 x 22mm	1 7/8" x 7/8"	M4
8	159034	140, 222, 904	Metal		34 x 27mm	1 5/16" x 1 1/16"	M4
9	157050	140, 222, 904	Metal	16mm	Ø 50 x 22mm	Ø 2" x 7/8"	M4
10	157030	140, 222, 904	Metal		Ø 30 x 20mm	Ø 1 3/16" x 3/4"	M4

REF. NO.	COLOR FINISH	MATERIAL DESCRIPTION	DIMENSION C.C.	OVERALL DIMENSION (L x P) METRIC	OVERALL DIMENSION (L x P) IMPERIAL	SCREW	
11	157069	140, 222, 904	Metal	32mm	Ø 69 x 24mm	Ø 2 11/16" x 15/16"	M4
12	256037	140, 222, 904	Metal		37 x 21mm	1 7/16" x 13/16"	M4
13	256049	140, 222, 904	Metal		49 x 28mm	1 15/16" x 1 1/16"	M4
14	256064	140, 222, 904	Metal	64mm	100 x 28mm	4" x 1 1/16"	M4
15	256128	140, 222, 904	Metal	128mm	188 x 28mm	7 3/8" x 1 1/16"	M4
16	308030	140, 222, 904	Metal		30 x 20mm	1 3/16" x 3/4"	M4
17	308045	140, 222, 904	Metal		45 x 24mm	1 3/4" x 15/16"	M4
18	308096	140, 222, 904	Metal	96mm	126 x 24mm	5" x 15/16"	M4
19	308128	140, 222, 904	Metal	128mm	178 x 24mm	7" x 15/16"	M4



REF. NO.	COLOR FINISH	MATERIAL DESCRIPTION	DIMENSION C.C.	OVERALL DIMENSION (L x P) METRIC	OVERALL DIMENSION (L x P) IMPERIAL	SCREW
1	870128 140, 222, 904	Metal	128mm	154 x 24mm	6" x 15/16"	M4
2	870096 140, 222, 904	Metal	96mm	121 x 24mm	4 3/4" x 15/16"	M4
3	870045 140, 222, 904	Metal		45 x 24mm	1 3/4" x 15/16"	M4
4	630160 140, 222, 904	Metal	160mm	174 x 21mm	6 13/16" x 13/16"	M4
5	630128 140, 222, 904	Metal	128mm	142 x 21mm	5 9/16" x 13/16"	M4
6	630096 140, 222, 904	Metal	96mm	110 x 21mm	4 5/16" x 13/16"	M4

REF. NO.	COLOR FINISH	MATERIAL DESCRIPTION	DIMENSION C.C.	OVERALL DIMENSION (L x P) METRIC	OVERALL DIMENSION (L x P) IMPERIAL	SCREW
7	408030 140, 222, 904	Metal		Ø 30 x 25mm	Ø 1 1/8" x 1"	M4
8	450096 140, 222, 904	Metal	96mm	154 x 25mm	6" x 1"	M4
9	450064 140, 222, 904	Metal	64mm	103 x 20mm	4" x 3/4"	M4
10	450164 140, 222, 904	Metal	64mm	84 x 22mm	3 5/16" x 7/8"	M4
11	870032 140, 222, 904	Metal	32mm	69 x 22mm	2 11/16" x 7/8"	M4



Real Size



# KEYHOLE PLATES



REF. NO.	COLOR FINISH	MATERIAL DESCRIPTION	OVERALL DIMENSION (L/W x H) METRIC	OVERALL DIMENSION (L/W x H) IMPERIAL	SCREW NAIL
1	88344 AE, 908	Metal	21 x 185mm	13/16" x 7 9/32"	285-xxx
2	30617180 BB, 130	Brass	19 x 180mm	3/4" x 7 3/32"	135140-xxx
3	8319.03 left 8319.02 right	900 Metal	22 x 190mm	7/8" x 7 15/32"	135140-xxx
4	8314.03 left 8314.02 right	900 Metal	16 x 140mm	5/8" x 5 1/2"	135140-xxx
5	21530.3 left 21530.2 right	800, 900, 908 Forged iron or brass	36 x 300mm	1 13/32" x 11 13/16"	135140-xxx
6	201271	800, 900, 908 Forged iron or brass.	30 x 37mm	1 3/16" x 1 15/32"	Nail incl.
7	201110	800, 900, 908 forged iron	18 x 100mm	23/32" x 3 15/16"	135140-xxx
8	3064338	BB, 130 Brass	25 x 38mm	1" x 1 1/2"	135140-xxx
9	3640338	BB, 130 Brass	38 x 25mm	1 1/2" x 1"	135140-xxx
10	3628176.3 left 3628176.2 right	BB Brass	20 x 176mm	25/32" x 6 15/16"	135140-xxx

REF. NO.	COLOR FINISH	MATERIAL DESCRIPTION	OVERALL DIMENSION (L/W x H) METRIC	OVERALL DIMENSION (L/W x H) IMPERIAL	SCREW NAIL
11	88348	AE, 130, 908 Metal	23 x 180mm	29/32" x 7 3/32"	287-xxx
12	30628130	BB, 130, 163, 164 Brass	130 x 24mm	5 1/8" x 15/16"	135140-xxx
13	4533144	134, 142 Metal	144 x 22mm	5 21/32" x 7/8"	285-xxx
14	4532144	134, 142 Metal	22 x 144mm	7/8" x 5 21/32"	285-xxx
15	3628137.3 left 3628137.2 right	BB, 130, 163 Brass	15 x 137mm	19/32" x 5 13/32"	135140-xxx
16	30639131.3 left 30639131.2 right	BB, 130 Brass	23 x 131mm	29/32" x 5 5/32"	135140-xxx
17	30565	BB, 130, 163 Brass	24 x 99mm	15/16" x 3 29/32"	135140-xxx
18	306357	BB, 904 Brass	20 x 57mm	25/32" x 2 1/4"	287-xxx
19	3565	BB, 163, 164 Brass	99 x 24mm	3 29/32" x 15/16"	135140-xxx
20	3069347	BB, 130, 163, 164, 904 Brass	24 x 47mm	15/16" x 1 27/32"	287-xxx

Nails and screws: see p.121

# KEYS AND LOCKS

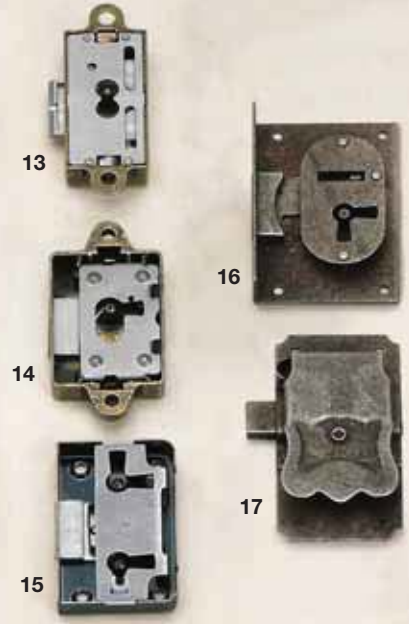

REF. NO.	COLOR FINISH	MATERIAL DESCRIPTION	OVERALL DIMENSION (W x H)		SCREW NAIL
			METRIC	IMPERIAL	
1	3572637 BB, 130	Brass mock key	24 x 38mm	1 5/16" x 1 1/2"	M4
2	33733 BB, 130	Brass key	28 x 76mm	1 3/32" x 3"	Universal
3	33104 BB, 130, 163, 164, 904	Brass key	35 x 75mm	1 3/8" x 2 15/16"	Universal
4	3372842 BB, 163, 904	Brass key	29 x 77mm	1 5/32" x 3 1/32"	Universal
5	35728 BB, 130, 163, 164, 904	Brass mock key	29 x 38mm	1 5/32" x 1 1/2"	M4
6	20850 800, 900, 908	Forged iron key	31 x 76mm	1 7/32" x 3"	To trim
7	8310 AE, 908	Metal key	31 x 76mm	1 7/32" x 3"	To trim
8	20803 130, 800, 900, 908	Forged iron or brass mock key	31 x 35mm	1 7/32" x 1 3/8"	M4
9	8312 AE, 908	Metal mock key	32 x 54mm	1 1/4" x 2 1/8"	M4
10	841831 134, 142	Metal mock key	31 x 13mm	1 7/32" x 1/2"	M4
11	3572446 BB, 130	Brass mock key	33 x 47mm	1 5/16" x 1 27/32"	M4
12	3372442 BB, 130	Brass key	33 x 85mm	1 5/16" x 3 11/32"	
13	187320.03 AE	Universal metal lock	28 x 75mm	1 3/32" x 2 15/16"	Wood screw

REF. NO.	COLOR FINISH	MATERIAL DESCRIPTION	OVERALL DIMENSION (W x H)		SCREW NAIL
			METRIC	IMPERIAL	
14	182620.03 AE	Left metal lock	38 x 75mm	1 1/2" x 2 15/16"	Wood screw
	182620.02 AE	Right metal lock	38 x 75mm	1 1/2" x 2 15/16"	Wood screw
15	180520 135	Metal universal lock	40 x 61mm	1 9/16" x 2 13/32"	Wood screw
16	75530.2 907	Right metal lock	49 x 70mm	1 15/16" x 2 3/4"	Screw or nail
17	77820 907	Right / left metal lock	41 x 81mm	1 5/8" x 3 3/16"	Screw or nail
18	210557	Zinc angular stricker plate	12 x 65mm	15/32" x 2 9/16"	Wood screw
19	202131	Zinc stricker plate	11 x 62mm	7/16" x 2 7/16"	Wood screw
20	30683 BB, 130, 163	Brass keyhole plate	14 x 24mm	9/16" x 15/16"	Knock in
21	603 2G, M41	Metal roller catch	35 x 30mm	1 3/8" x 1 3/16"	Wood screw
22	5531 130	Brass double bead catch	44 x 12mm	1 23/32" x 15/32"	Wood screw
23	55334 130	Double brass catch	58 x 16mm	2 9/32" x 5/8"	Wood screw
24	9700 2G	Metal friction catch	34 x 29mm	1 11/32" x 1 5/32"	Wood screw
25	5540 130	Brass elbow catch	30 x 40mm	1 3/16" x 1 9/16"	Wood screw
26	3675 2G	Metal elbow catch	26 x 42mm	1 1/32" x 1 21/32"	Wood screw

Nails and screws: see p.121



# CHEST HARDWARE

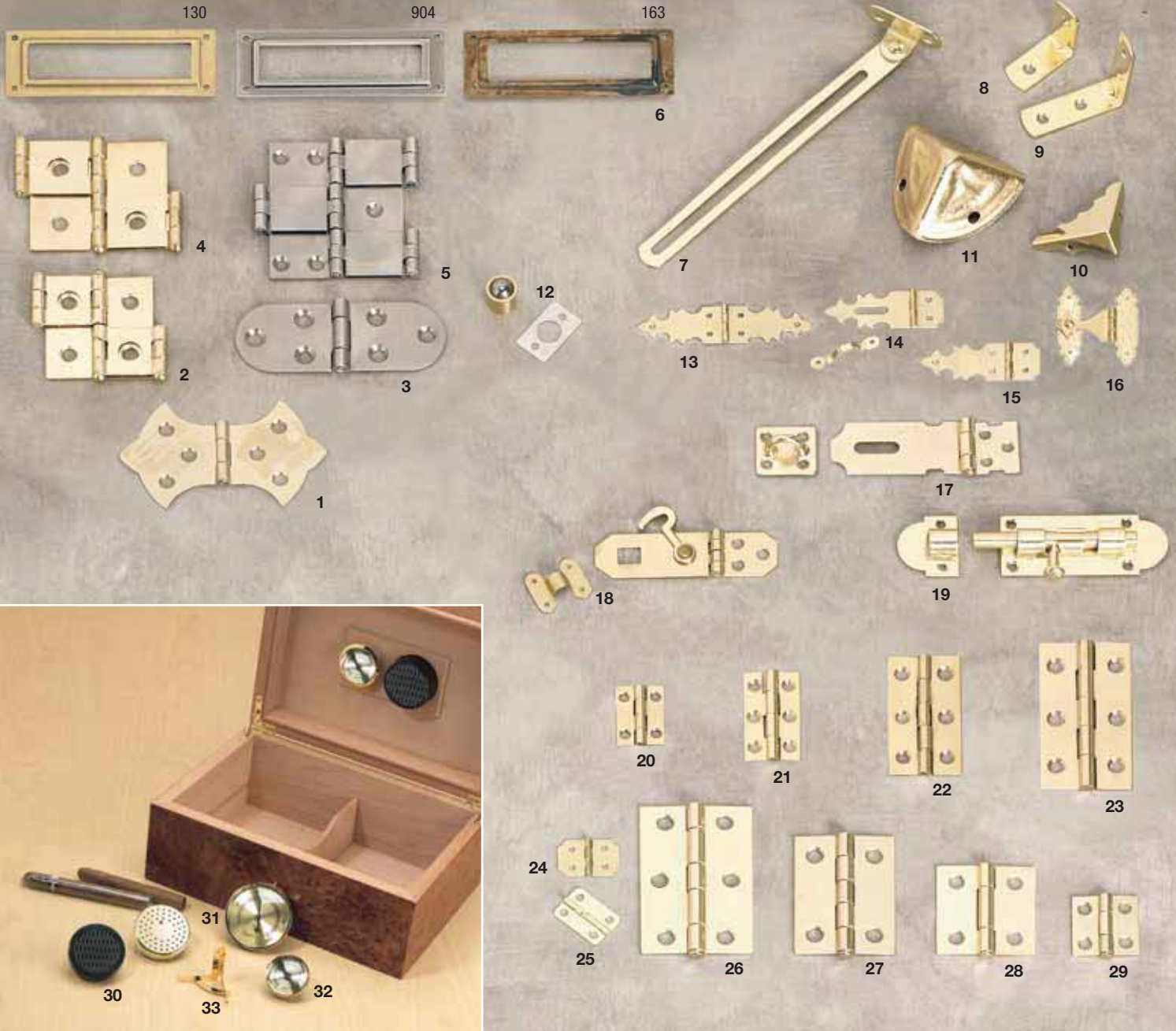

REF. NO.	COLOR FINISH	MATERIAL DESCRIPTION	DIMENSION C.C. / Ø	OVERALL DIMENSION (H x L/W) METRIC	OVERALL DIMENSION (H x L/W) IMPERIAL	SCREW NAIL
1	690492 130	Brass decorative hinge	19 x 33mm	3/4" x 1 5/16"	Wood screw	
	690490 130	Brass decorative hinge	25 x 40mm	1" x 1 9/16"	Wood screw	
2	20861 130	Brass folding screen hinge	19 x 45mm	3/4" x 1 25/32"	Wood screw	
3	75083 170	Stainless steel table hinge	81 x 30mm	3 3/16" x 1 3/16"	Wood screw	
4	20862 130	Brass folding screen hinge	25 x 48mm	1" x 1 7/8"	Wood screw	
5	75060 170	Brass double action hinge	64 x 60mm	2 17/32" x 2 3/8"	Wood screw	
6	45123 130, 163, 904	Brass card holder	80 x 29mm	3 5/32" x 1 5/32"	287-xxx	
7	690204 130	Metal chest lid support	140 x 33mm	5 1/2" x 1 5/16"	Wood screw	
8	6909610 130	Brass angle	25 x 25mm	1" x 1"	Wood screw	
9	6909615 130	Brass angle	38 x 38mm	1 1/2" x 1 1/2"	Wood screw	
10	69064 130	Brass decorative corner	13 x 32mm	1/2" x 1 1/4"	Nail	
11	69066 130	Metal decorative corner	38 x 38mm	1 1/2" x 1 1/2"	Nail	
12	690485 130	Brass bullet catch	Ø 7/16"		Nail	
13	690585 130	Brass decorative hinge	16 x 70mm	5/8" x 2 3/4"	Nail	
14	690340 130	Brass decorative hinge	16 x 46mm	5/8" x 1 3/4"	Nail	
15	690587 130	Brass decorative hinge	16 x 46mm	5/8" x 1 3/4"	Nail	
16	690506 130	Brass decorative hinge	35 x 32mm	1 3/8" x 1 1/4"	Nail	
17	690341 130	Brass hasp	25 x 70mm	1" x 2 3/4"	Wood screw	

REF. NO.	COLOR FINISH	MATERIAL DESCRIPTION	DIMENSION C.C. / Ø	OVERALL DIMENSION (H x L/W) METRIC	OVERALL DIMENSION (H x L/W) (L x P)* IMPERIAL	SCREW NAIL
18	690343 130	Brass hook and staple	25 x 70mm	1" x 2 3/4"	Wood screw & Nail	
19	690355 130	Brass barrel bolt	25 x 86mm	1" x 3 3/8"	Wood screw	
20	690591 130	Brass hinge	25 x 19mm	1" x 3/4"	Wood screw	
21	690592 130	Brass hinge	38 x 22mm	1 1/2" x 7/8"	Wood screw	
22	690593 130	Brass hinge	51 x 29mm	2" x 1 1/8"	Wood screw	
23	690594 130	Brass hinge	64 x 35mm	2 1/2" x 1 3/8"	Wood screw	
24	690589 130	Brass hinge	16 x 25mm	5/8" x 1"	Nail	
25	690590 130	Brass hinge	22 x 14mm	7/8" x 9/16"	Nail	
26	690843 130	Brass hinge	64 x 41mm	2 1/2" x 1 5/8"	Wood screw	
27	690842 130	Brass hinge	51 x 38mm	2" x 1 1/2"	Wood screw	
28	690841 130	Brass hinge	38 x 38mm	1 1/2" x 1 1/2"	Wood screw	
29	690840 130	Brass hinge	25 x 25mm	1" x 1"	Wood screw	
30	01457 90	Humidifier	Ø 57mm	*57 x 14mm	2 1/4" x 9/16"	
31	02070 130	Hygrometer	Ø 70mm	*70 x 20mm	2 3/4" x 25/32"	
32	20656 130	Brass hinge		*41 x 44mm	1 5/8" x 1 23/32"	Nail
33	02044 130	Hygrometer	Ø 44mm	*44 x 20mm	1 23/32" x 25/32"	

Nails and screws: see p.121

# HINGES

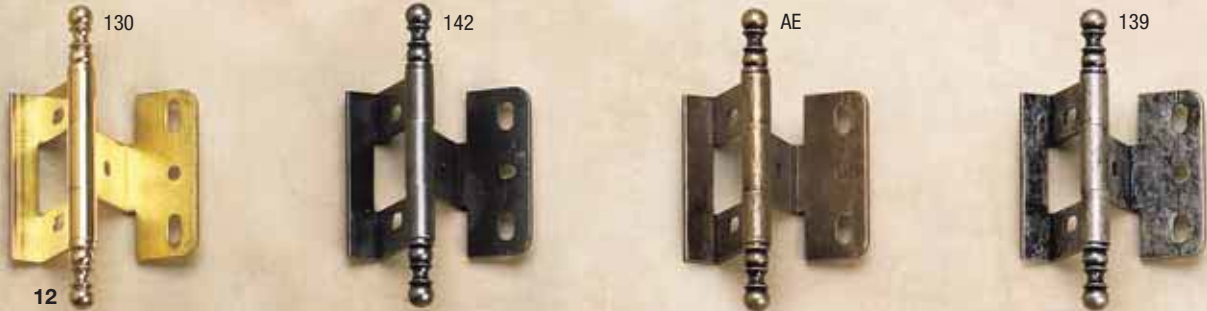
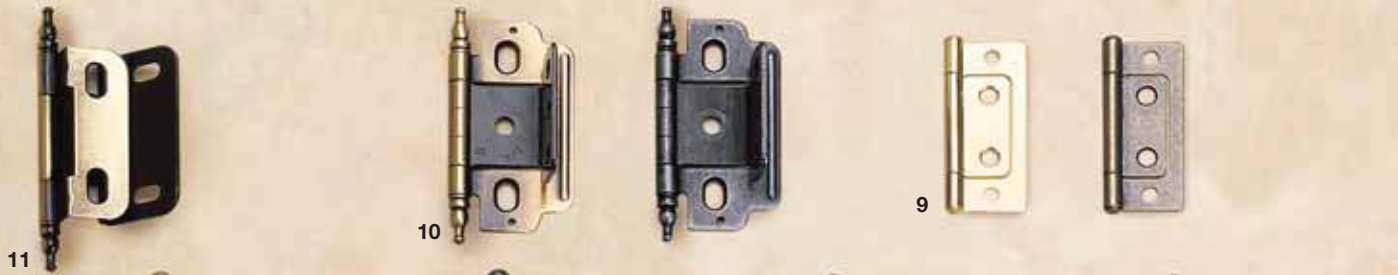
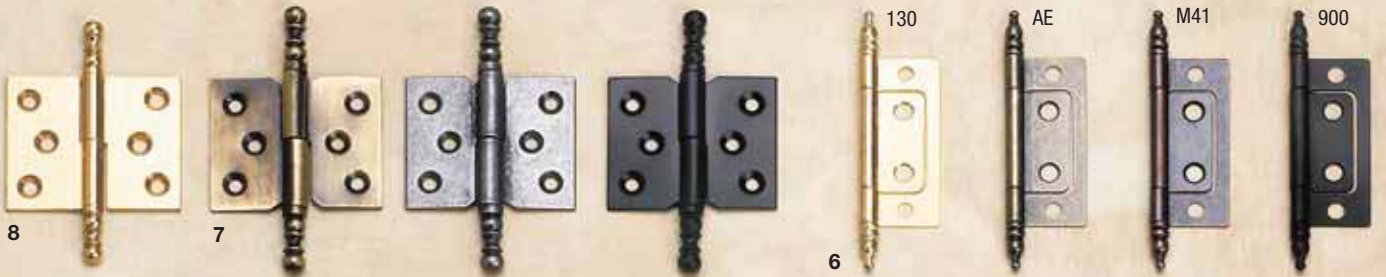
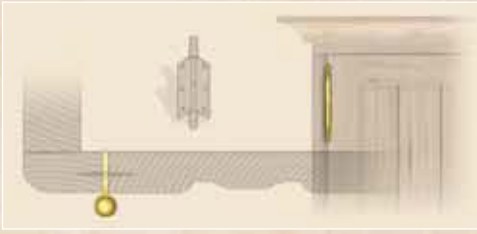

REF. NO.	COLOR FINISH	MATERIAL DESCRIPTION	DIMENSION BLADE	OVERALL DIMENSION (H, Ø) METRIC	OVERALL DIMENSION (H, Ø) IMPERIAL	SCREW NAIL
1	83175 AE, BB, BORB, 130, 195, 907	Metal		70mm	2 3/4"	Wood screw
2	20642 130, M41	Metal	2 1/2"	89mm	3 1/2"	Wood screw
3	20643 130, M41	Metal	3"	102mm	4 1/32"	Wood screw
4	8406.03 left 8406.02 right	Metal	60 x 40mm	98mm, 7mm	3 27/32", 9/32"	Wood screw
5	8416.03 left 8416.02 right	Metal	60 x 40mm	90mm, 6mm	3 17/32", 1/4"	Wood screw
6	2064 AE, 130, 900, M41	Metal	2"	77mm	3 1/32"	Wood screw

REF. NO.	COLOR FINISH	MATERIAL DESCRIPTION	DIMENSION BLADE	OVERALL DIMENSION (H, Ø) METRIC	OVERALL DIMENSION (H, Ø) IMPERIAL	SCREW NAIL
7	8404.03 left 8404.02 right	Metal	40 x 50mm	78mm, 7mm	3 1/16", 9/32"	Wood screw
8	8414.03 left 8414.02 right	Brass	40 x 50mm	70mm, 6mm	2 3/4", 1/4"	Wood screw
9	2050 AE, 130, 185, 900, M41	Metal		51mm	2"	Wood screw
10	83180 130, 195, 907	Metal		70mm	2 3/4"	Wood screw
11	7687 AE, 130	Metal		79mm	3 1/8"	Wood screw
12	5102 AE, 130, 139, 142, 195	Brass		89mm	3 1/2"	Wood screw

Nails and screws: see p.121



REF. NO.	COLOR FINISH	MATERIAL DESCRIPTION	BLADE DIMENSION (H)		LEAF THICKNESS		OVERALL DIMENSION (W x H)		FINIAL TYPE	SCREW	
			METRIC	IMPERIAL	METRIC	IMPERIAL	METRIC	IMPERIAL			
1	54101	AE, BORB, 142, 180, 195, 900	Brass	50mm	1 15/16"	2mm	5/64"	57mm x 92mm	2 1/4" x 3 5/8"	Urn	Wood screw incl.
2	5201	AE, BORB, 142, 180, 195, 900	Brass	50mm	1 15/16"	2mm	5/64"	37mm x 75mm	1 7/16" x 2 15/16"	Urn	Wood screw incl.
3	53101	AE, BORB, 142, 180, 195, 900	Brass	50mm	1 15/16"	1.5mm	1/16"	40.5mm x 70mm	1 5/8" x 2 3/4"	Urn	Wood screw incl.
4	54301	AE, BORB, 142, 180, 195, 900	Brass	50mm	1 15/16"	2mm	5/64"	57mm x 54mm	2 1/4" x 2 1/8"	Flat	Wood screw incl.
5	5203	AE, BORB, 142, 180, 195, 900	Brass	50mm	1 15/16"	2mm	5/64"	37mm x 53mm	1 7/16" x 2 1/8"	Flat	Wood screw incl.
6	53103	AE, BORB, 142, 180, 195, 900	Brass	50mm	1 15/16"	1.5mm	1/16"	40.5mm x 53mm	1 5/8" x 2 1/8"	Flat	Wood screw incl.



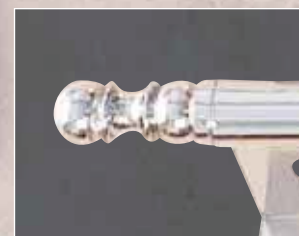

Real size



REF. NO.	COLOR FINISH	MATERIAL DESCRIPTION	BLADE DIMENSION (H)		LEAF THICKNESS		OVERALL DIMENSION (W x H)		FINIAL TYPE	SCREW	
			METRIC	IMPERIAL	METRIC	IMPERIAL	METRIC	IMPERIAL			
1	54201	AE, BORB, 142, 180, 195, 900	Brass	50mm	1 15/16"	2mm	5/64"	57mm x 92mm	2 1/4" x 3 5/8"	Ball	Wood screw incl.
2	5202	AE, BORB, 142, 180, 195, 900	Brass	50mm	1 15/16"	2mm	5/64"	37mm x 65mm	1 7/16" x 2 9/16"	Ball	Wood screw incl.
3	53102	AE, BORB, 142, 180, 195, 900	Brass	50mm	1 15/16"	1.5mm	1/16"	40.5mm x 62mm	1 5/8" x 2 7/16"	Ball	Wood screw incl.

# LIFT-OFF HINGES AND CREMONE BOLTS

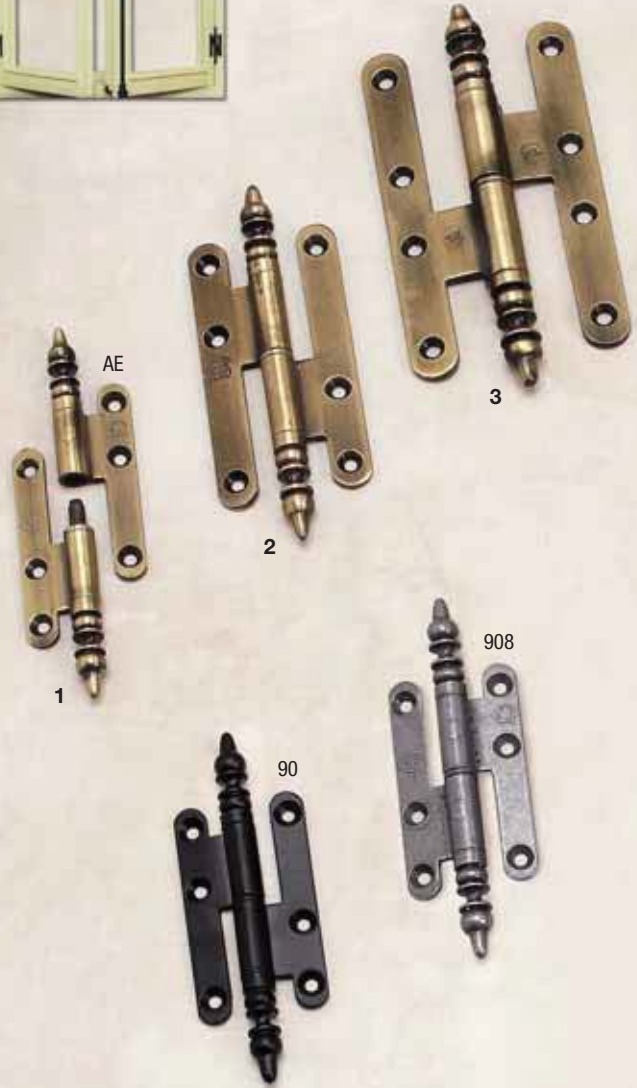

REF. NO.	COLOR FINISH	MATERIAL DESCRIPTION	DIMENSION BLADE	OVERALL DIMENSION (H) METRIC	OVERALL DIMENSION (H) IMPERIAL	SCREW NAIL
1	8138045.2 right 8138045.3 left	AE, 90, 908 Brass or steel	80 x 45mm	107mm	4 7/32"	Wood screw
2	81311055.2 right 81311055.3 left	AE, 90, 908 Brass or steel	110 x 55mm	147mm	5 25/32"	Wood screw
3	81314080.2 right 81314080.3 left	AE, 90, 908 Brass or steel	140 x 80mm	160mm	6 5/16"	Wood screw

REF. NO.	COLOR FINISH	MATERIAL DESCRIPTION	DESCRIPTION	DIMENSION	SCREW NAIL
4	88843 908 AE, 90	Steel Steel	Lift-off hinges	2 bars of 1.6m / 63" 2 bars of 1.3m / 51 3/16"	Wood screw incl. Wood screw incl.

Nails and screws: see p.121

# LATCHES AND SURFACE BOLTS



REF. NO.	COLOR FINISH	MATERIAL DESCRIPTION	DIMENSION C.C. / Ø	OVERALL DIMENSION METRIC	OVERALL DIMENSION (L x P) IMPERIAL	SCREW NAIL
1	BORB, 195	Metal latch	36mm c.c.	49 x 40mm	1 15/16" x 1 9/16"	Wood screw
		Metal plate	36mm c.c.	48 x 26mm	1 7/8" x 1"	Wood screw
2	BORB, 195	Metal latch	36mm c.c.	49 x 40mm	1 15/16" x 1 9/16"	Wood screw
		Metal plate	37mm c.c.	50 x 26mm	1 15/16" x 1"	Wood screw
3	BORB, 195	Metal surface bolts		100 x 29mm	3 15/16" x 1 1/8"	Wood screw
4	BORB, 195	Metal surface bolts		149 x 29mm	5 1/2" x 1 1/8"	Wood screw

REF. NO.	COLOR FINISH	MATERIAL DESCRIPTION	DIMENSION C.C. / Ø	OVERALL DIMENSION METRIC	OVERALL DIMENSION (L x P) IMPERIAL	SCREW NAIL
5	BORB, 195	Metal surface bolts		179 x 29mm	7" x 1 1/8"	Wood screw
6	BORB, 195	Metal magnet	37mm c.c.	15 x 51mm	9/16" x 2"	Wood screw
		Metal plate	44mm.c.c.	57 x 13mm	2 1/4" x 1/2"	Wood screw
7	BORB, 180, 195	Metal latch		27 x 46mm	1 1/16" x 1 13/16"	Wood screw
		Metal plate		47 x 11mm	1 7/8" x 7/16"	Wood screw

# HINGES AND PIVOT HINGES



1



2



BB

2



900



908



130



800



7



3

4



5

## SPLIT HINGES



6

REF. NO.	COLOR FINISH	MATERIAL DESCRIPTION	DIMENSION Ø	OVERALL DIMENSION (H) METRIC	OVERALL DIMENSION (H) IMPERIAL	SCREW NAIL
1	21009	Forged iron or brass pivot hinge	Ø 8mm	90mm	3 17/32"	Wood screw
	21012		Ø 10mm	120mm	4 23/32"	Wood screw
	21014		Ø 10mm	140mm	5 1/2"	Wood screw
	21016		Ø 10mm	160mm	6 5/16"	Wood screw
	21019		Ø 12mm	190mm	7 15/32"	Wood screw
2	21130	Forged iron or brass pivot hinge	Ø 13mm	300mm	11 13/16"	Wood screw
	21140		Ø 13mm	400mm	15 3/4"	Wood screw
	21150		Ø 13mm	500mm	19 11/16"	Wood screw
	21160		Ø 13mm	600mm	23 5/8"	Wood screw
	21170		Ø 13mm	700mm	27 9/16"	Wood screw
	21180		Ø 13mm	800mm	31 1/2"	Wood screw

REF. NO.	COLOR FINISH	MATERIAL DESCRIPTION	BLADE DIMENSION	OVERALL DIMENSION (H, Ø) METRIC	OVERALL DIMENSION (H, Ø) IMPERIAL	SCREW NAIL
3	88988	AE, 90, 130, 908	Metal	100mm, 9mm	3 15/16", 11/32"	
4	81009	AE, 90, 130, 908	Metal	66mm, 9mm	2 19/32", 11/32"	
5	80070	AE, 90, 904, 908	Metal	70mm	4 19/32", 13/32"	Wood screw
6	810150	AE, 90, 908	Metal	50mm	3 5/8", 13/32"	Wood screw
7	172026		Grooving chisel	26mm, 2mm	1 1/32", 3/32"	
	172030		Grooving chisel	30mm, 2mm	1 3/16", 3/32"	

Nail and screws: see p.121

# FORGED IRON HINGES



REF. NO.	COLOR FINISH	MATERIAL DESCRIPTION	OVERALL DIMENSION (L/W x H) METRIC	OVERALL DIMENSION (L/W x H) IMPERIAL	SCREW NAIL
1 1140	907	Forged iron	300 x 60mm	11 13/16" x 2 3/8"	Wood screw
2 548040	907	Forged iron	40 x 55mm	1 9/16" x 2 5/32"	Wood screw
3 489125	907	Forged iron	70 x 125mm	2 3/4" x 4 29/32"	Wood screw
4 489100	907	Forged iron	55 x 100mm	2 5/32" x 3 15/16"	Wood screw
5 111485	907	Forged iron	85 x 52mm	3 11/32" x 2 1/16"	Wood screw

REF. NO.	COLOR FINISH	MATERIAL DESCRIPTION	OVERALL DIMENSION (L/W x H) METRIC	OVERALL DIMENSION (L/W x H) IMPERIAL	SCREW NAIL
6 112916	900	Forged iron	150 x 60mm	5 29/32" x 2 3/8"	Wood screw
7 122611	907	Forged iron	16 x 110mm	5/8" x 4 11/32"	Wood screw
8 122514	907	Forged iron	55 x 135mm	2 5/32" x 5 5/16"	Wood screw
9 2002.3 left	90	Forged iron	137mm	5 13/32"	Wood screw
2002.2 right	90	Forged iron	137mm	5 13/32"	Wood screw

Nails and screws: see p.121



# EXPRESSION



REF. NO.	COLOR FINISH	MATERIAL DESCRIPTION	DIMENSION C.C. / Ø	OVERALL DIMENSION (L x P) METRIC	OVERALL DIMENSION (L x P) IMPERIAL	SCREW NAIL
1	7544526 170	Stainless steel	526mm c.c.	534 x 31mm	21" x 1 7/32"	8/32
2	7544257 170	Stainless steel	257mm c.c.	265 x 31mm	10 7/16" x 1 7/32"	8/32
3	7544160 170	Stainless steel	160mm c.c.	167 x 31mm	6 9/16" x 1 7/32"	8/32
4	754496 170	Stainless steel	96mm c.c.	104 x 31mm	4 1/16" x 1 7/32"	8/32
5	86072128 BORB, 195	Metal	128mm c.c.	153 x 36mm	6" x 1 13/32"	8/32
6	64664 195	Metal	64mm c.c.	79 x 20mm	3 1/8" x 25/32"	M4
7	31925 195	Metal	16mm c.c.	25 x 20mm	1" x 25/32"	M4
8	61641625 195	Metal	25 x 25mm	25 x 24mm	1" x 15/16"	M4
9	6132896 BORB, 143, 180, 195	Metal	96mm c.c.	136 x 25mm	5 5/16" x 1"	8/32
10	680256 195	Metal	256mm c.c.	265 x 30mm	10 7/16" x 1 3/16"	M4
11	458192 195, 196	Metal	192mm c.c.	202 x 26mm	7 9/16" x 1 1/32"	8/32
12	458160 195, 196	Metal	160mm c.c.	171 x 26mm	6 23/32" x 1 1/32"	8/32
13	458128 195	Metal	128mm c.c.	138 x 26mm	5 7/16" x 1 1/32"	8/32
14	873224 BORB, 195, 180, 143	Metal	224mm c.c.	254 x 35mm	10" x 1 3/8"	8/32
15	873192 BORB, 195, 180, 143	Metal	192mm c.c.	202 x 35mm	8" x 1 3/8"	8/32
16	873160 BORB, 195, 180, 143	Metal	160mm c.c.	170 x 35mm	6 11/16" x 1 3/8"	8/32
17	873128 BORB, 195, 180, 143	Metal	128mm c.c.	138 x 35mm	5 7/16" x 1 3/8"	8/32

REF. NO.	COLOR FINISH	MATERIAL DESCRIPTION	DIMENSION C.C. / Ø	OVERALL DIMENSION (L x P) METRIC	OVERALL DIMENSION (L x P) IMPERIAL	SCREW NAIL
18	87396 BORB, 195, 180, 143	Metal	96mm c.c.	106 x 35mm	4 1/8" x 1 3/8"	8/32
19	84150 BORB, 195	Metal	32mm c.c.	42 x 25mm	1 21/32" x 1"	8/32
20	8160192 BORB, 195	Metal	192mm c.c.	222 x 28mm	8 3/4" x 1 1/16"	8/32
21	8160160 BORB, 195	Metal	160mm c.c.	191 x 28mm	7 1/2" x 1 1/16"	8/32
22	8160128 BORB, 195	Metal	128mm c.c.	162 x 28mm	6 3/8" x 1 1/16"	8/32
23	816096 BORB, 195	Metal	96mm c.c.	113 x 26mm	4 7/16" x 1 1/16"	8/32
24	816032 BORB, 195	Metal	32mm c.c.	57 x 26mm	2 1/4" x 1 1/16"	8/32
25	5139632 BORB, 195	Metal	32mm c.c.	70 x 21mm	2 3/4" x 13/16"	8/32
26	8102116 BORB, 195	Metal	16mm c.c.	40 x 18mm	1 9/16" x 23/32"	8/32
27	80338 AE, BORB, 143, 180, 195	Metal	38mm c.c.	38 x 27mm	1 1/2" x 1 1/16"	8/32
28	312456160 BORB, 174, 195	Metal	160mm c.c.	167 x 27mm	6 9/16" x 1 1/16"	8/32
29	31604325 BORB, 174, 195	Metal	25 x 25mm	25 x 25mm	1" x 1"	8/32
30	10748 140, 195	Metal	8" c.c.	212 x 25mm	8 3/8" x 1"	8/32
31	10746 140, 195	Metal	6" c.c.	162 x 25mm	6 3/8" x 1"	8/32
32	1076 140	Metal	4" c.c.	110 x 23mm	4 11/32" x 29/32"	8/32
33	10743 140, 195	Metal	3" c.c.	87 x 25mm	3 3/8 x 1"	8/32



REF. NO.	COLOR FINISH	MATERIAL DESCRIPTION	DIMENSION C.C. / Ø	OVERALL DIMENSION (L x P) METRIC	OVERALL DIMENSION (L x P) IMPERIAL	SCREW NAIL
1	810192 AE, BORB, 143, 180, 195	Metal	192mm c.c.	205 x 28mm	8 1/16" x 1 1/16"	8/32
2	810160 AE, BORB, 143, 180, 195	Metal	160mm c.c.	173 x 27mm	6 13/16" x 1 1/16"	8/32
3	810128 AE, BORB, 143, 180, 195	Metal	128mm c.c.	140 x 28mm	5 1/2" x 1 1/16"	8/32
4	81092 AE, BORB, 142, 143, 180, 195	Metal	96mm c.c.	108 x 27mm	4 1/4" x 1 1/16"	8/32
5	81076 AE, BORB, 143, 180, 195	Metal	3" c.c.	89 x 28mm	3 1/2" x 1 1/16"	8/32
6	863192 AE, BORB, 143, 180, 195	Metal	192mm c.c.	214 x 30mm	8 3/8" x 1 3/16"	8/32
7	863160 AE, BORB, 143, 180, 195	Metal	160mm c.c.	182 x 30mm	7 1/8" x 1 3/16"	8/32
8	863128 AE, BORB, 143, 180, 195	Metal	128mm c.c.	150 x 30mm	5 7/8" x 1 3/16"	8/32
9	86396 AE, BORB, 143, 180, 195	Metal	96mm c.c.	118 x 30mm	4 5/8" x 1 3/16"	8/32
10	86376 AE, BORB, 143, 180, 195	Metal	3" c.c.	97 x 30mm	3 13/16" x 1 3/16"	8/32
11	80930 AE, BORB, 143, 180, 195	Metal	Ø 30mm	30 x 25mm	1 3/16" x 1"	8/32
12	14630 AE, BORB, 195	Brass	Ø 30mm	30 x 22mm	1 3/16" x 7/8"	8/32

REF. NO.	COLOR FINISH	MATERIAL DESCRIPTION	DIMENSION C.C. / Ø	OVERALL DIMENSION (L x P) METRIC	OVERALL DIMENSION (L x P) IMPERIAL	SCREW NAIL
13	81045 AE, BORB, 143, 195	Metal	43 x 43mm	43 x 35mm	1 11/16" x 1 3/8"	8/32
14	81091 AE, BORB, 142, 180, 195	Metal	31 x 31mm	31 x 25mm	1 7/32" x 1"	8/32
15	80239 AE, BORB, 143, 180, 195	Metal	Ø 39mm	39 x 26mm	1 1/2" x 1"	8/32
16	8252128 BORB, 195	Metal	128mm c.c.	159 x 26mm	6 1/4" x 1"	8/32
17	825296 BORB, 143, 180, 195	Metal	96mm c.c.	127 x 26mm	5" x 1"	8/32
18	825276 BORB, 143, 180, 195	Metal	3" c.c.	107 x 26mm	4 3/16" x 1"	8/32
19	650192 AE, BORB, 143, 180, 195	Metal	192mm c.c.	276 x 32mm	10 7/8" x 1 1/4"	8/32
20	650128 AE, BORB, 143, 180, 195	Metal	128mm c.c.	198 x 31mm	7 3/4" x 1 3/16"	8/32
21	65096 AE, BORB, 143, 180, 195	Metal	96mm c.c.	158 x 29mm	6 3/16" x 1 1/8"	8/32
22	65076 AE, BORB, 143, 180, 195	Metal	3" c.c.	135 x 27mm	5 5/16" x 1"	8/32
23	65038 AE, BORB, 143, 180, 195	Metal		38 x 27mm	1 1/2" x 1"	8/32





REF. NO.	COLOR FINISH	MATERIAL DESCRIPTION	DIMENSION C.C. / Ø	OVERALL DIMENSION (L x P) METRIC	OVERALL DIMENSION (L x P) IMPERIAL	SCREW NAIL
1	85991288 195	Metal	288mm c.c.	368 x 32mm	14 1/2" x 1 1/4"	8/32
2	85993160 195	Metal	160mm c.c.	203 x 30mm	8" x 1 3/16"	8/32
3	860957 AE, BORB, 143, 180, 195	Metal	16mm c.c.	58 x 23mm	2 1/4" x 7/8"	8/32
4	860857 AE, BORB, 143, 180, 195	Metal	16mm c.c./Ø 58mm	58 x 22mm	2 1/4" x 13/16"	8/32
5	21064 BORB, 180, 195	Metal	64mm c.c.	100 x 22mm	4" x 13/16"	8/32
6	805128 BORB, 180, 195, 143	Metal	128mm c.c.	149 x 30mm	5 13/16" x 1 3/16"	8/32

REF. NO.	COLOR FINISH	MATERIAL DESCRIPTION	DIMENSION C.C. / Ø	OVERALL DIMENSION (L x P) METRIC	OVERALL DIMENSION (L x P) IMPERIAL	SCREW NAIL
7	80596 BORB, 195, 180, 143	Metal	96mm c.c.	116 x 28mm	4 9/16" x 1 1/16"	8/32
8	80576 AE, BORB, 143, 180, 195	Metal	3" c.c.	96 x 28mm	3 3/4" x 1 1/16"	8/32
9	811128 BORB, 143, 180, 195	Metal	128mm c.c.	155 x 32mm	5" x 1 1/4"	8/32
10	81196 AE, BORB, 143, 180, 195	Metal	96mm c.c.	123 x 32mm	4 13/16" x 1 1/4"	8/32
11	81176 BORB, 143, 180, 195	Metal	3" c.c.	103 x 32mm	4" x 1 1/4"	8/32



REF. NO.	COLOR FINISH	MATERIAL DESCRIPTION	DIMENSION C.C. / Ø	OVERALL DIMENSION (L x P) METRIC	OVERALL DIMENSION (L x P) IMPERIAL	SCREW NAIL
1	820192 AE, BORB, 143, 180, 195	Metal	192mm c.c.	202 x 28mm	7 15/16" x 1 1/16"	8/32
2	820160 AE, BORB, 143, 180, 195	Metal	160mm c.c.	170 x 25mm	6 11/16" x 1"	8/32
3	820128 AE, BORB, 143, 180, 195	Metal	128mm c.c.	138 x 24mm	5 7/16" x 1"	8/32
4	82096 AE, BORB, 143, 180, 195	Metal	96mm c.c.	106 x 24mm	4 1/8" x 1"	8/32
5	82076 AE, BORB, 143, 180, 195	Metal	76mm c.c.	86 x 24mm	3 3/8" x 1"	8/32
6	815192 AE, BORB, 143, 180, 195	Metal	192mm c.c.	211 x 30mm	8 1/4" x 1 3/16"	8/32
7	815160 AE, BORB, 143, 180, 195	Metal	160mm c.c.	179 x 30mm	7" x 1 3/16"	8/32
8	815128 AE, BORB, 143, 180, 195	Metal	128mm c.c.	147 x 30mm	5 3/4" x 1 3/16"	8/32
9	81596 AE, BORB, 143, 180, 195	Metal	96mm c.c.	115 x 30mm	4 1/2" x 1 3/16"	8/32
10	81576 AE, BORB, 143, 180, 195	Metal	3" c.c.	96 x 30mm	3 3/4" x 1 3/16"	8/32
11	821192 AE, BORB, 143, 180, 195	Metal	192mm c.c.	238 x 25mm	9 3/8" x 1"	8/32

REF. NO.	COLOR FINISH	MATERIAL DESCRIPTION	DIMENSION C.C. / Ø	OVERALL DIMENSION (L x P) METRIC	OVERALL DIMENSION (L x P) IMPERIAL	SCREW NAIL
12	821160 AE, BORB, 143, 180, 195	Metal	160mm c.c.	206 x 25mm	8 1/16" x 1"	8/32
13	821128 AE, BORB, 143, 180, 195	Metal	128mm c.c.	174 x 25mm	6 13/16" x 1"	8/32
14	82196 AE, BORB, 143, 180, 195	Metal	96mm c.c.	138 x 24mm	5 7/16" x 1"	8/32
15	82176 AE, BORB, 143, 180, 195	Metal	3" c.c.	118 x 24mm	4 5/8" x 1"	8/32
16	814192 BORB, 143, 180, 195	Metal	192mm c.c.	200 x 29mm	7 7/8" x 1 1/8"	8/32
17	814160 BORB, 143, 180, 195	Metal	160mm c.c.	178 x 29mm	7" x 1 1/8"	8/32
18	814128 BORB, 143, 180, 195	Metal	128mm c.c.	146 x 29mm	5 3/4" x 1 1/8"	8/32
19	81496 BORB, 143, 180, 195	Metal	96mm c.c.	114 x 29mm	4 1/2" x 1 1/8"	8/32
20	814332 AE, BORB, 143, 180, 195	Metal	31 x 31mm	31 x 25mm	1 3/16" x 1"	8/32
21	7438096 BORB, 143, 180, 195	Metal	96mm c.c.	109 x 30mm	1 1/4" x 1 3/16"	8/32



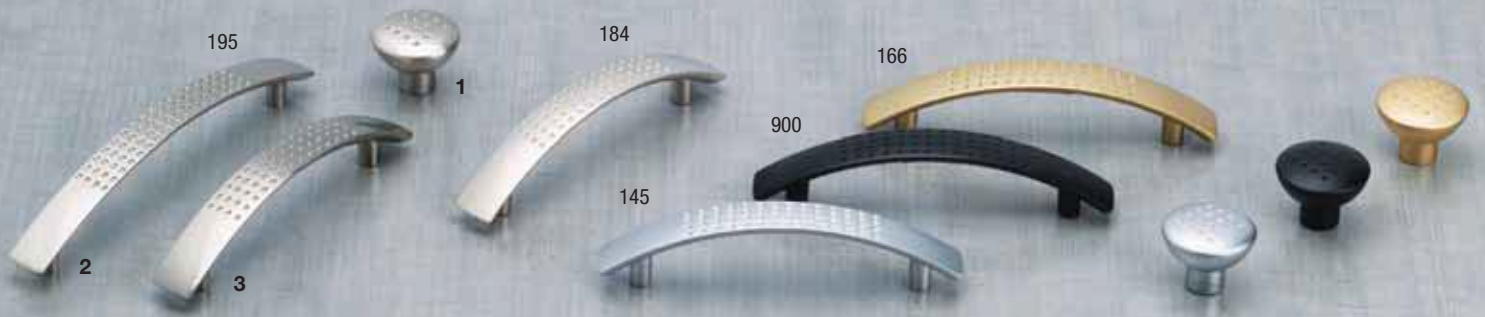

REF. NO.	COLOR FINISH	MATERIAL DESCRIPTION	DIMENSION C.C. / Ø	OVERALL DIMENSION (L x P) METRIC	OVERALL DIMENSION (L x P) IMPERIAL	SCREW NAIL
1	2608	145, 166, 195, 900 Metal	Ø 34mm	34 x 27mm	1 11/32" x 1 1/16"	8/32
2	2602128	195 Metal	128mm c.c.	158 x 32mm	6 7/32" x 1 1/4"	8/32
3	2602	145, 166, 184 Metal	96mm c.c.	127 x 29mm	5" x 1 5/32"	8/32
4	6501	195 Metal	128mm c.c.	200 x 33mm	7 7/8" x 1 5/16"	8/32
5	10888128	195 Metal	128mm c.c.	170 x 29mm	6 11/16" x 1 5/32"	8/32
6	33038	184, 195 Metal	96mm c.c.	145 x 26mm	5 23/32" x 1 1/32"	8/32
7	65000128	195 Metal	128mm c.c.	179 x 27mm	7 1/16" x 1 1/16"	8/32
8	650286	145 Metal	128mm c.c.	168 x 31mm	6 5/8" x 1 7/32"	8/32
9	4601128	184 Aluminium	128mm c.c.	150 x 20mm	5 29/32" x 25/32"	8/32
10	650319	185 Metal	160mm c.c.	174 x 32mm	6 27/32" x 1 1/4"	8/32

REF. NO.	COLOR FINISH	MATERIAL DESCRIPTION	DIMENSION C.C. / Ø	OVERALL DIMENSION (L x P) METRIC	OVERALL DIMENSION (L x P) IMPERIAL	SCREW NAIL
11	10542128	195 Metal	128mm c.c.	153 x 26mm	6 1/32" x 1 1/32"	8/32
12	268096	174 Metal	96mm c.c.	107 x 32mm	4 7/32" x 1 1/4"	8/32
13	39995	174 Metal	128mm c.c.	146 x 30mm	5 3/4" x 1 3/16"	8/32
14	1068520	145 Metal	96mm c.c.	142 x 27mm	5 19/32" x 1 1/16"	M4
15	1068519	145 Metal	25 x 27mm	25 x 27mm	1" x 1 1/16"	M4
16	438696	174,195 Metal	96mm c.c.	116 x 20mm	4 9/16" x 25/32"	8/32
17	438632	174,195 Metal	32mm c.c.	61 x 20mm	2 13/32" x 25/32"	8/32
18	438616	174,195 Metal	16mm c.c.	30 x 20mm	1 3/16" x 25/32"	8/32
19	312456160	174, 195 Metal	160mm c.c.	167 x 27mm	6 9/16" x 1 1/16"	8/32
20	31604325	174, 195 Metal	25 x 25mm	25 x 25mm	1" x 1"	8/32



REF. NO.	COLOR FINISH	MATERIAL DESCRIPTION	DIMENSION C.C. / Ø	OVERALL DIMENSION (L x P) METRIC	OVERALL DIMENSION (L x P) IMPERIAL	SCREW NAIL
1	50128	140, 195 Brass	Ø 28mm	28 x 30mm	1 3/32" x 1 3/16"	8/32
2	50930	140, 195 Brass	Ø 30mm	30 x 25mm	1 3/16" x 1"	8/32
3	1443	140, 195 Brass		20 x 32mm	25/32" x 1 1/4"	8/32
4	59841	195 Metal	192mm c.c.	223 x 34mm	8 3/4" x 1 11/32"	M4
5	608160	195 Metal	160mm c.c.	186 x 34mm	7 5/16" x 1 11/32"	M4
6	0525128	195 Metal	128mm c.c.	165 x 30mm	6 1/2" x 1 3/16"	8/32
7	240296	195 Brass	96mm c.c.	130 x 33mm	5 1/8" x 1 5/16"	8/32
8	240143	195 Brass		43 x 30mm	1 21/32" x 1 3/16"	8/32
9	6504	195 Metal	128mm c.c.	189 x 30mm	7 7/16" x 1 3/16"	8/32

REF. NO.	COLOR FINISH	MATERIAL DESCRIPTION	DIMENSION C.C. / Ø	OVERALL DIMENSION (L x P) METRIC	OVERALL DIMENSION (L x P) IMPERIAL	SCREW NAIL
10	833128	195 Metal	128mm c.c.	176 x 32mm	6 15/16" x 1 1/4"	8/32
11	8661	195 Metal	128mm c.c.	157 x 32mm	6 3/16" x 1 1/4"	M4
12	2559160	195 Metal	160mm c.c.	231 x 41mm	9 3/32" x 1 5/8"	8/32
13	2559128	195 Metal	128mm c.c.	186 x 36mm	7 5/16" x 1 13/32"	8/32
14	255996	195 Metal	96mm c.c.	124 x 32mm	4 7/8" x 1 1/4"	8/32
15	31636132	195 Brass	32mm c.c.	87 x 18mm	3 7/16" x 23/32"	8/32
16	31636016	195 Brass	16mm c.c.	54 x 15mm	2 1/8" x 19/32"	8/32
17	356392	195 Brass		40 x 22mm	1 9/16" x 7/8"	8/32





REF. NO.	COLOR FINISH	MATERIAL DESCRIPTION	DIMENSION C.C. / Ø	OVERALL DIMENSION (L x P) METRIC	OVERALL DIMENSION (L x P) IMPERIAL	SCREW NAIL
1	80845128 184, 900	Metal	128mm c.c.	275 x 18mm	10 13/16" x 23/32"	8/32
2	80896 184, 900	Metal	96mm c.c.	171 x 20mm	6 23/32" x 25/32"	8/32
3	322696 900	Metal	96mm c.c.	170 x 19mm	6 11/16" x 3/4"	8/32
4	33848 195	Metal	128mm c.c.	160 x 32mm	6 5/16" x 1 1/4"	8/32
5	80710160 BB,195,900,908	Metal	160mm c.c.	179 x 30mm	7 1/16" x 1 3/16"	8/32
6	58264 195	Metal	64mm c.c.	84 x 20mm	3 5/16" x 25/32"	M4
7	88896 195, 900	Metal	96mm c.c.	110 x 15mm	4 11/32" x 9/32"	8/32
8	88864 195, 900	Metal	64mm c.c.	75 x 14mm	2 15/16" x 9/16"	8/32
9	426 140, 195	Metal	32mm c.c.	90 x 23mm	3 17/32" x 29/32"	8/32
10	356011 195	Metal	Ø 30mm	30 x 26mm	1 3/16" x 1 1/32"	8/32
11	T46702 195	Metal	Ø 32mm	32 x 28mm	1 1/4" x 1 3/32"	8/32
12	7061 195, 900	Metal	96mm c.c.	130 x 28mm	5 1/8" x 1 3/32"	M4

REF. NO.	COLOR FINISH	MATERIAL DESCRIPTION	DIMENSION C.C. / Ø	OVERALL DIMENSION (L x P) METRIC	OVERALL DIMENSION (L x P) IMPERIAL	SCREW NAIL
13	8692 195, 900	Metal	Ø 14mm	14 x 26mm	9/16" x 1 1/32"	M4
14	53082 140, 174, 184, 195, 900	Metal	32 x 32mm	32 x 32mm	1 1/4" x 1 1/4"	8/32
15	459 183, 900	Metal	96mm c.c.	107 x 20mm	4 7/32" x 25/32"	M4
16	9734 183, 900	Metal	34 x 23mm	34 x 23mm	1 11/32" x 29/32"	M4
17	0621128 195	Metal	128mm c.c.	149 x 29mm	5 7/8" x 1 5/32"	M4
18	62196 183, 900	Metal	96mm c.c.	113 x 28mm	4 7/16" x 1 3/32"	M4
19	16930 183, 195, 900	Metal	Ø 30mm	30 x 23mm	1 3/16" x 29/32"	M4
20	216495 195	Metal	16mm c.c.	29 x 20mm	1 5/32" x 25/32"	8/32
21	8045732 195	Metal	32mm c.c.	52 x 18mm	2 1/16" x 23/32"	8/32
22	38197 195	Metal	39 x 29mm	39 x 29mm	1 17/32" x 1 5/32"	8/32
23	33103 195	Metal	96mm c.c.	107 x 26mm	4 7/32" x 1 1/32"	8/32
24	2586 140	Metal	64mm c.c.	70 x 21mm	2 3/4" x 13/16"	8/32



REF. NO.	COLOR FINISH	MATERIAL DESCRIPTION	DIMENSION C.C. / Ø	OVERALL DIMENSION METRIC	OVERALL DIMENSION (L x P) IMPERIAL	SCREW NAIL
1	25110160 140/195	Metal	160mm c.c.	172 x 30mm	6 25/32" x 1 3/16"	8/32
2	25110128 140/195	Metal	128mm c.c.	140 x 28mm	5 1/2" x 1 3/32"	8/32
3	2511096 130/195, 140/195	Metal	96mm c.c.	108 x 28mm	4 1/4" x 1 3/32"	8/32
4	2558160 140/195	Metal	160mm c.c.	200 x 30mm	7 7/8" x 1 3/16"	8/32
5	255896 140/195	Metal	96mm c.c.	134 x 30mm	5 9/32" x 1 3/16"	8/32
6	2561128 140/195	Metal	128mm c.c.	147 x 31mm	5 25/32" x 1 7/32"	8/32
7	256196 140/195	Metal	96mm c.c.	114 x 31mm	4 1/2" x 1 7/32"	8/32
8	25296 140/195	Metal	96mm c.c.	130 x 25mm	5 1/8" x 1"	8/32
9	252128 140/195	Metal	128mm c.c.	163 x 28mm	6 13/32" x 1 3/32"	8/32

REF. NO.	COLOR FINISH	MATERIAL DESCRIPTION	DIMENSION C.C. / Ø	OVERALL DIMENSION METRIC	OVERALL DIMENSION (L x P) IMPERIAL	SCREW NAIL
10	25232 140/195	Metal	32mm c.c.	52 x 31mm	2 1/16" x 1 7/32"	8/32
11	2530725 140, 195	Metal	Ø 25mm	25 x 23mm	1" x 29/32"	8/32
12	2511725 140/195	Metal		25 x 23mm	1" x 29/32"	8/32
13	2511720 140/195	Metal		20 x 23mm	3/4" x 29/32"	8/32
14	252096 140/195	Metal	96mm c.c.	104 x 31mm	4 3/32" x 1 7/32"	8/32
15	2520128 140/195	Metal	128mm c.c.	135 x 31mm	5 5/16" x 1 7/32"	8/32
16	251442 130/195, 140/195	Metal		47 x 27mm	1 27/32" x 1 1/16"	8/32
17	2514138 130/195, 140/195	Metal		38 x 25mm	1 1/2" x 1"	8/32
18	251541 195	Metal		45 x 26mm	1 25/32" x 1 1/32"	8/32





REF. NO.	COLOR FINISH	MATERIAL DESCRIPTION	DIMENSION C.C. / Ø	OVERALL DIMENSION (L x P) METRIC	OVERALL DIMENSION (L x P) IMPERIAL	SCREW NAIL	
1	765304	AE, BORB, 143, 180, 195	Metal	12" c.c.	354 x 50mm	13 15/16" x 1 15/16"	8/32
2	765192	AE, BORB, 143, 180, 195	Metal	192mm c.c.	230 x 33mm	9" x 1 1/4"	8/32
3	765160	AE, BORB, 143, 180, 195	Metal	160mm c.c.	198 x 33mm	7 3/4" x 1 1/4"	8/32
4	765128	AE, BORB, 143, 180, 195	Metal	128mm c.c.	166 x 33mm	6 1/2" x 1 1/4"	8/32
5	76596	AE, BORB, 143, 180, 195	Metal	3"/96mm c.c.	115 x 30mm	4 1/2" x 1 3/16"	8/32
6	76544	AE, BORB, 143, 180, 195	Metal		44 x 30mm	1 7/16" x 1 3/16"	8/32
7	76533	AE, BORB, 143, 180, 195	Metal	33 x 33mm	33 x 32mm	1 1/4" x 1 1/4"	8/32
8	785192	AE, BORB, 143, 180, 195	Metal	192mm c.c.	200 x 35mm	7 7/8" x 1 3/8"	8/32
9	785160	AE, BORB, 143, 180, 195	Metal	160mm c.c.	168 x 35mm	6 9/16" x 1 3/8"	8/32
10	785128	AE, BORB, 143, 180, 195	Metal	128mm c.c.	136 x 35mm	5 5/16" x 1 3/8"	8/32
11	78596	AE, BORB, 143, 180, 195	Metal	96mm c.c.	104 x 35mm	4 1/16" x 1 3/8"	8/32
12	78576	AE, BORB, 143, 180, 195	Metal	3" c.c.	83 x 30mm	3 1/4" x 1 3/16"	8/32
13	78532	AE, BORB, 143, 180, 195	Metal		48 x 28mm	1 1/4" x 1 5/16"	8/32
14	78535	AE, BORB, 143, 180, 195	Metal	32 x 32mm	32 x 33mm	1 1/4" x 1 1/4"	8/32

REF. NO.	COLOR FINISH	MATERIAL DESCRIPTION	DIMENSION C.C. / Ø	OVERALL DIMENSION (L x P) METRIC	OVERALL DIMENSION (L x P) IMPERIAL	SCREW NAIL	
15	770192	AE, BORB, 143, 180, 195	Metal	192mm c.c.	204 x 32mm	8" x 1 1/4"	8/32
16	770160	AE, BORB, 143, 180, 195	Metal	160mm c.c.	172 x 32mm	6 3/4" x 1 1/4"	8/32
17	770128	AE, BORB, 143, 180, 195	Metal	128mm c.c.	140 x 32mm	5 1/2" x 1 1/4"	8/32
18	77096	AE, BORB, 143, 180, 195	Metal	96mm c.c.	108 x 32mm	4 1/4" x 1 1/4"	8/32
19	77076	AE, BORB, 143, 180, 195	Metal	3" c.c.	86 x 29mm	3 3/8" x 1 1/8"	8/32
20	77035	AE, BORB, 143, 180, 195	Metal	35 x 35mm	35 x 30mm	1 3/8" x 1 3/16"	8/32
21	77043	AE, BORB, 143, 180, 195	Metal	43 x 30mm	43 x 30mm	1 11/16" x 1 3/16"	8/32
22	795192	AE, BORB, 143, 180, 195	Metal	192mm c.c.	212 x 35mm	8 5/16" x 1 3/8"	8/32
23	795160	AE, BORB, 143, 180, 195	Metal	160mm c.c.	180 x 35mm	7 1/16" x 1 3/8"	8/32
24	795128	AE, BORB, 143, 180, 195	Metal	128mm c.c.	148 x 35mm	5" x 1 3/8"	8/32
25	79596	AE, BORB, 143, 180, 195	Metal	3"/96mm c.c.	106 x 35mm	4 1/8" x 1 3/8"	8/32
26	79532	AE, BORB, 143, 180, 195	Metal	32 x 32mm	32 x 32mm	1 1/4" x 1 1/4"	8/32
27	79538	AE, BORB, 143, 180, 195	Metal		38 x 32mm	1 1/2" x 1 1/4"	8/32



REF. NO.	COLOR FINISH	MATERIAL DESCRIPTION	DIMENSION C.C. / Ø	OVERALL DIMENSION (L x P) METRIC	OVERALL DIMENSION (L x P) IMPERIAL	SCREW NAIL	
1	740304	AE, BORB, 143, 180, 195	Metal	12" c.c.	329 x 50mm	13" x 1 15/16"	M6
2	740192	AE, BORB, 143, 180, 195	Metal	192mm c.c.	205 x 33mm	8 1/16" x 1 1/4"	8/32
3	740160	AE, BORB, 143, 180, 195	Metal	160mm c.c.	173 x 33mm	6 13/16" x 1 1/4"	8/32
4	740128	AE, BORB, 143, 180, 195	Metal	128mm c.c.	141 x 33mm	5 1/2" x 1 1/4"	8/32
5	74096	AE, BORB, 143, 180, 195	Metal	96mm c.c.	109 x 33mm	4 1/4" x 1 1/4"	8/32
6	74076	AE, BORB, 143, 180, 195	Metal	3" c.c.	87 x 30mm	3 3/8" x 1 3/16"	8/32
7	74032	AE, BORB, 143, 180, 195	Metal	Ø 32mm	32 x 33mm	1 1/4" x 1 5/16"	8/32
8	74043	AE, BORB, 143, 180, 195	Metal		43 x 33mm	1 11/16" x 1 1/4"	8/32
9	775192	AE, BORB, 143, 180, 195	Metal	192mm c.c.	222 x 33mm	8 3/4" x 1 1/4"	8/32
10	775160	AE, BORB, 143, 180, 195	Metal	160mm c.c.	190 x 33mm	7 1/2" x 1 1/4"	8/32
11	775128	AE, BORB, 143, 180, 195	Metal	128mm c.c.	158 x 33mm	6 3/16" x 1 1/4"	8/32
12	77596	AE, BORB, 143, 180, 195	Metal	3"/96mm c.c.	116 x 33mm	4 9/16" x 1 1/4"	8/32
13	77533	AE, BORB, 143, 180, 195	Metal		43 x 33mm	1 11/16" x 1 1/4"	8/32
14	77535	AE, BORB, 143, 180, 195	Metal	35 x 35mm	35 x 33mm	1 3/8" x 1 5/16"	8/32

REF. NO.	COLOR FINISH	MATERIAL DESCRIPTION	DIMENSION C.C. / Ø	OVERALL DIMENSION (L x P) METRIC	OVERALL DIMENSION (L x P) IMPERIAL	SCREW NAIL	
15	780192	AE, BORB, 143, 180, 195	Metal	192mm c.c.	233 x 36mm	9 1/8" x 1 1/4"	8/32
16	780160	AE, BORB, 143, 180, 195	Metal	160mm c.c.	201 x 36mm	7 7/8" x 1 1/4"	8/32
17	780128	AE, BORB, 143, 180, 195	Metal	128mm c.c.	169 x 36mm	6 5/8" x 1 1/4"	8/32
18	78096	AE, BORB, 143, 180, 195	Metal	3"/96mm c.c.	127 x 36mm	5" x 1 1/4"	8/32
19	78033	AE, BORB, 143, 180, 195	Metal		43 x 33mm	1 11/16" x 1 5/16"	8/32
20	78035	AE, BORB, 143, 180, 195	Metal	35x35mm	35 x 33mm	1 3/8" x 1 5/16"	8/32
21	790192	AE, BORB, 143, 180, 195	Metal	192mm c.c.	208 x 40mm	8 3/16" x 1 9/16"	8/32
22	790160	AE, BORB, 143, 180, 195	Metal	160mm c.c.	176 x 40mm	7" x 1 9/16"	8/32
23	790128	AE, BORB, 143, 180, 195	Metal	128mm c.c.	144 x 40mm	5 11/16" x 1 9/16"	8/32
24	79096	AE, BORB, 143, 180, 195	Metal	96mm c.c.	112 x 40mm	4 7/16" x 1 9/16"	8/32
25	79076	AE, BORB, 143, 180, 195	Metal	3" c.c.	90 x 30mm	3 1/2" x 1 3/16"	8/32
26	79032	AE, BORB, 143, 180, 195	Metal	Ø 32mm	32 x 33mm	1 1/4" x 1 5/16"	8/32
27	79040	AE, BORB, 143, 180, 195	Metal		40 x 33mm	1 9/16" x 1 5/16"	8/32



REF. NO.	COLOR FINISH	MATERIAL DESCRIPTION	DIMENSION C.C. / Ø	OVERALL DIMENSION (L x P/H) METRIC	OVERALL DIMENSION (L x P/H) IMPERIAL	SCREW NAIL
1	82432 AE, BORB, 142, 195	Metal	3" c.c.	85 x 27mm	3 11/32" x 1 1/16"	8/32
2	80977 AE, BORB, 142, 195	Metal	96mm c.c.	110 x 28mm	4 11/32" x 1 3/32"	8/32
3	80976 AE, BORB, 142, 195	Metal		48 x 17mm	1 7/8" x 1 1/16"	8/32
4	82619 AE, BORB, 142, 195	Metal	Ø 32mm	32 x 28mm	1 1/4" x 1 3/32"	8/32
5	82917 AE, BORB, 142, 195	Metal plate	Ø 38mm	38 x 5mm	1 1/2" x 3/16"	
6	82465 AE, BORB, 142, 195	Metal	Ø 32mm	32 x 29mm	1 1/4" x 1 1/8"	8/32
7	82908 AE, BORB, 142, 195	Metal plate		106 x 26mm	4 3/16" x 1 1/32"	

REF. NO.	COLOR FINISH	MATERIAL DESCRIPTION	DIMENSION C.C. / Ø	OVERALL DIMENSION (L x P) METRIC	OVERALL DIMENSION (L x P) IMPERIAL	SCREW NAIL
8	8048 130, 195	Brass	Ø 38mm	38 x 37mm	1 1/2" x 1 15/32"	8/32
9	8050 130	Brass	Ø 25mm	25 x 22mm	1" x 7/8"	8/32
10	86060 AE, BORB, 130, 142	Metal	Ø 32mm	32 x 36mm	1 1/4" x 1 13/32"	8/32
11	82261 AE, BORB, 142, 195	Metal	96mm c.c.	115 x 35mm	4 17/32" x 1 3/8"	8/32
12	80237 AE, BORB, 142, 195	Metal	96mm c.c.	127 x 34mm	5" x 1 11/32"	8/32
13	82262 AE, BORB, 195	Metal	12" c.c.	335 x 43mm	13 3/16" x 1 11/16"	8/32



REF. NO.	COLOR FINISH	MATERIAL DESCRIPTION	DIMENSION C.C. / Ø	OVERALL DIMENSION (L x P) METRIC	OVERALL DIMENSION (L x P) IMPERIAL	SCREW NAIL
1	18439 BORB, 142, 195	Metal	Ø 43mm	43 x 40mm	1 11/16" x 1 9/16"	8/32
2	60111 BORB, 142, 180, 195	Metal	4" c.c.	155 x 39mm	6 1/16" x 1 17/32"	8/32
3	1455 BORB, 142, 195	Solid brass	96mm c.c.	126 x 29mm	4 31/32" x 1 5/32"	8/32
4	1454 BORB, 142, 195	Solid brass	3 1/2"	120 x 30mm	4 23/32" x 1 3/16"	8/32
5	8632 AE, BORB, 142, 180, 195	Metal	Ø 30mm	30 x 26mm	1 3/16" x 1 1/32"	8/32
6	30737 AE, BORB, 142, 180, 195	Metal	3" c.c.	124 x 24mm	4 7/8" x 1 5/16"	8/32
30796	AE, BORB, 143, 195	Metal	96mm c.c.	142 x 27mm	5 9/16" x 1 1/16"	8/32

REF. NO.	COLOR FINISH	MATERIAL DESCRIPTION	DIMENSION C.C. / Ø	OVERALL DIMENSION (L x P) METRIC	OVERALL DIMENSION (L x P) IMPERIAL	SCREW NAIL
7	5120530 AE, BORB, 142, 195	Metal	Ø 30mm	30 x 34mm	1 3/16" x 1 11/32"	8/32
8	20304 AE, BORB, 142, 195	Metal	Ø 1 1/4"	32 x 32mm	1 1/4" x 1 1/4"	8/32
9	40302 AE, BORB, 142, 195	Metal	96mm c.c.	110 x 32mm	4 5/16" x 1 1/4"	8/32
10	209 AE, BORB, 142, 195	Metal	Ø 32mm	32 x 25mm	1 1/4" x 1"	8/32
11	802128 AE, BORB, 195	Metal	128mm c.c.	140 x 36mm	5 1/2" x 1 7/16"	8/32
12	80296 AE, BORB, 195	Metal	96mm c.c.	108 x 33mm	4 1/4" x 1 5/16"	8/32
13	80290 AE, BORB, 142, 180, 195	Metal	3" c.c.	85 x 32mm	3 5/16" x 1 1/4"	8/32
14	82290 AE, BORB, 195	Metal	12" c.c.	350 x 55mm	13 3/4" x 2 5/32"	8/32







REF. NO.	COLOR FINISH	MATERIAL DESCRIPTION	DIMENSION C.C. / Ø	OVERALL DIMENSION (L x P) METRIC	OVERALL DIMENSION (L x P) IMPERIAL	SCREW NAIL
1	30388 AE, BB, BORB, ORB, 91, 140, 142, 195	Brass	3" c.c.	88 x 35mm	3 1/8" x 1 3/8"	8/32
2	9161196 AE, BORB, 142, 180, 195	Metal	96mm c.c.	130 x 28mm	5 1/8" x 1 1/4"	8/32
3	81224 AE, BORB, 142, 180, 195	Metal	Ø 44mm	44 x 35mm	1 3/4" x 1 3/8"	8/32
4	80980 AE, BORB, 142, 180, 195	Metal	Ø 32mm	32 x 26mm	1 1/4" x 1 1/32"	8/32
5	26987 BORB, 195	Metal	128mm c.c.	160 x 31mm	6 5/16" x 1 7/32"	8/32
6	46702 BORB, 195	Metal	Ø 32mm	32 x 28mm	1 1/4" x 1 3/32"	8/32
7	444350 AE, BORB, 143, 195	Metal		50 x 45mm	1 15/16" x 1 3/4"	8/32
8	444340 AE, BORB, 142, 195	Metal		40 x 42mm	1 9/16" x 1 21/32"	8/32

REF. NO.	COLOR FINISH	MATERIAL DESCRIPTION	DIMENSION C.C. / Ø	OVERALL DIMENSION (L x P) METRIC	OVERALL DIMENSION (L x P) IMPERIAL	SCREW NAIL
9	4443 BORB, 130, 140, 142, 195, 900	Metal		30 x 33mm	1 3/16" x 1 5/16"	8/32
10	51278192 BORB, 143, 180, 195	Metal	192mm c.c.	208 x 32mm	8 3/16" x 1 1/4"	8/32
11	51278128 BORB, 143, 180, 195	Metal	128mm c.c.	144 x 32mm	5 11/16" x 1 1/4"	8/32
12	5127896 BORB, 143, 180, 195	Metal	96mm c.c.	112 x 32mm	4 3/8" x 1 1/4"	8/32
13	7815 AE, BORB, 130, 142, 195	Metal	128mm c.c.	160 x 33mm	6 5/16" x 1 5/16"	8/32
14	7814 195	Metal	96mm c.c.	126 x 24mm	4 31/32" x 15/16"	8/32
15	492338 AE, BORB, 142, 195	Metal	Ø 38mm	38 x 32mm	1 1/2" x 1 1/4"	8/32
16	3923 AE, BORB, 140, 195, 900	Solid Brass	Ø 1 1/4"	32 x 30mm	1 1/4" x 1 3/16"	8/32





REF. NO.	COLOR FINISH	MATERIAL DESCRIPTION	DIMENSION C.C. / Ø	OVERALL DIMENSION (L x P) METRIC	OVERALL DIMENSION (L x P) IMPERIAL	SCREW NAIL
1	85820304 195	Metal	12" c.c.	356 x 35mm	14" x 1 3/8"	8/32
2	85820192 195	Metal	192mm c.c.	238 x 31mm		8/32
3	85820160 195, 140, 900	Metal	160mm c.c.	182 x 30mm	7 5/32" x 1 3/16"	8/32
4	85820128 195	Metal	128mm c.c.	174 x 31mm		8/32
5	82905128 140, 174, 195	Metal	128mm c.c.	155 x 27mm	6 3/32" x 1 1/16"	8/32
6	8290596 140, 195	Metal	96mm c.c.	119 x 26mm	4 11/16" x 1 1/32"	8/32
7	3511 130, 140, 142, 195, 900	Metal	96mm c.c.	114 x 29mm	4 1/2" x 1 5/32"	8/32
8	7815 195	Metal	128mm c.c.	160 x 33mm	6 5/16" x 1 5/16"	8/32

REF. NO.	COLOR FINISH	MATERIAL DESCRIPTION	DIMENSION C.C. / Ø	OVERALL DIMENSION (L x P) METRIC	OVERALL DIMENSION (L x P) IMPERIAL	SCREW NAIL
9	7814 AE, BORB, 91, 140, 142, 193, 195, 900	Metal	96mm c.c.	126 x 24mm	4 31/32" x 1 5/16"	8/32
10	9041 AE, BORB, ORB, 91, 130, 140, 142, 175, 191, 193, 195, 900	Metal	Ø 30mm	30 x 28mm	1 3/16" x 1 3/32"	8/32
11	26202128 140, 174, 195	Metal	128mm c.c.	155 x 33mm	6 3/32" x 1 5/16"	8/32
12	23103128 195	Metal	128mm c.c.	165 x 28mm	6 1/2" x 1 3/32"	8/32
13	2310396 195	Metal	96mm c.c.	106 x 22mm	4 3/16" x 7/8"	8/32
14	30700 BB, 130, 180	Metal	96mm c.c.	125 x 28mm	4 29/32" x 1 3/32"	8/32



REF. NO.	COLOR FINISH	MATERIAL DESCRIPTION	DIMENSION C.C. / Ø	OVERALL DIMENSION (L x P) METRIC	OVERALL DIMENSION (L x P) IMPERIAL	SCREW NAIL
1	496288 184	Metal	288mm c.c.	322 x 31mm	12 11/16" x 1 7/32"	M4
2	496160 184	Metal	160mm c.c.	183 x 28mm	7 7/32" x 1 3/32"	8/32
3	272192 174, 900	Metal	192mm c.c.	228 x 33mm	8 31/32" x 1 5/16"	8/32
4	3986 195	Metal	192mm c.c.	229 x 33mm	9 31/32" x 1 5/16"	8/32
5	272160 174	Metal	160mm c.c.	196 x 33mm	7 23/32" x 1 5/16"	8/32
6	7438096 BORB, 143, 180, 195	Metal	96mm c.c.	109 x 30mm	1 1/4" x 1 3/16"	8/32

REF. NO.	COLOR FINISH	MATERIAL DESCRIPTION	DIMENSION C.C. / Ø	OVERALL DIMENSION (L x P) METRIC	OVERALL DIMENSION (L x P) IMPERIAL	SCREW NAIL
7	5923 AE, BB, ORB, 30, 90, 91, 130, 140, 142, 160, 174, 175, 184, 191, 193, 195, 900	Metal	Ø 1 1/4"	32 x 31mm	1 1/4" x 1 7/32"	8/32
8	65017 AE, BB, BORB, 30, 90, 91, 130, 140, 142, 160, 174, 184, 191, 193, 195, 900	Metal	96mm c.c.	132 x 29mm	5 3/16" x 1 5/32"	8/32
9	39965 ORB, 195	Metal	128mm c.c.	164 x 33mm	6 15/32" x 1 5/16"	8/32
10	16338 BORB, 174, 195, 184, 900	Metal	128mm c.c.	151 x 28mm	5 15/16" x 1 3/32"	8/32
11	16396 BORB, 195	Metal	96mm c.c.	115 x 23mm	4 1/2" x 7/8"	8/32





Handle which complies with Americans with Disabilities Act (ADA) requirements.



REF. NO.	COLOR FINISH	MATERIAL DESCRIPTION	DIMENSION C.C. / Ø	OVERALL DIMENSION (L x P) METRIC	OVERALL DIMENSION (L x P) IMPERIAL	SCREW NAIL
1	6211288 184, 900	Metal	288mm c.c./ Ø 10mm	298 x 28mm	11 23/32" x 1 3/32"	M4
2	271 195	Metal	288mm c.c./ Ø 10mm	298 x 28mm	11 23/32" x 1 3/32"	M4
3	0141128* 170	Stainless	128mm c.c.	136 x 73mm	5 11/32" x 2 7/8"	8/32
4	33285 ORB, 195, 900	Metal	128mm c.c.	137 x 28mm	5 13/32" x 1 3/32"	8/32
5	2214 175	Metal	4" c.c.	110 x 31mm	4 11/32" x 1 7/32"	8/32
6	22135 175	Metal	3 1/2" c.c.	97 x 31mm	3 13/16" x 1 7/32"	8/32
7	2213 175	Metal	3" c.c.	84 x 31mm	3 5/16" x 1 7/32"	8/32
8	515 160, 195	Brass	4" c.c.	110 x 30mm	4 11/32" x 1 3/16"	8/32
9	505 140, 195	Brass	96mm c.c.	104 x 30mm	4 3/32" x 1 3/16"	8/32
10	510 140, 195	Brass	3" c.c.	84 x 30mm	3 5/16" x 1 3/16"	8/32
11	221 170	Stainless	4" c.c.	110 x 35mm	4 11/32" x 1 3/8"	8/32
12	6211192 BORB, 195	Metal	192mm c.c.	202 x 32mm	7 15/16" x 1 1/4"	M4
13	6211128 BORB, 195	Metal	128mm c.c.	138 x 32mm	5 7/16" x 1 1/4"	M4
14	621196 BORB, 195	Metal	96mm c.c.	106 x 32mm	4 1/8" x 1 1/4"	M4

REF. NO.	COLOR FINISH	MATERIAL DESCRIPTION	DIMENSION C.C. / Ø	OVERALL DIMENSION (L x P) METRIC	OVERALL DIMENSION (L x P) IMPERIAL	SCREW NAIL
15	280 195	Metal	8" c.c.	210 x 28mm	8 1/4" x 1 3/32"	8/32
16	260 195	Metal	6" c.c.	159 x 28mm	6 1/4" x 1 3/32"	8/32
17	240 195	Metal	4" c.c.	109 x 28mm	4 9/32" x 1 3/32"	8/32
18	255 130, 195	Metal	3 1/2" c.c.	96 x 28mm	3 25/32" x 1 3/32"	8/32
19	33205 ORB, 140, 174, 195	Metal	96mm c.c.	104 x 30mm	4 3/32" x 1 3/16"	8/32
20	33204 130, 140, 195	Metal	3 1/2" c.c.	97 x 30mm	3 13/16" x 1 3/16"	8/32
21	33206 BORB, 140, 195	Metal	4" c.c.	110 x 30mm	4 11/32" x 1 3/16"	8/32
22	33203 91, 140, 174, 195	Metal	3" c.c.	84 x 30mm	3 5/16" x 1 3/16"	8/32
	263 174	Steel	3" c.c.	84 x 30mm	3 5/16" x 1 3/16"	8/32
	2635 174	Steel	3 1/2" c.c.	97 x 30mm	3 13/16" x 1 3/16"	8/32
	264 174	Steel	4" c.c.	111 x 30mm	4 3/8" x 1 3/16"	8/32
	266 174	Steel	6" c.c.	160 x 35mm	6 1/4" x 1 3/8"	8/32
	296 174	Steel	96mm c.c.	105 x 30mm	4 1/8" x 1 3/16"	8/32
23	33205 170	Stainless	96mm c.c.	104 x 30mm	4 3/32" x 1 3/16"	8/32
24	425 145	Metal	3 1/2" c.c.	97 x 30mm	3 13/16" x 1 3/16"	8/32

\* Handle which complies with Americans with Disabilities Act (ADA) requirements.



REF. NO.	COLOR FINISH	MATERIAL DESCRIPTION	DIMENSION C.C. / Ø	OVERALL DIMENSION (L x P) METRIC	OVERALL DIMENSION (L x P) IMPERIAL	SCREW NAIL	
1	30576	BORB, 143, 195	Metal	76mm c.c.	156 x 35mm	6 1/4" x 1 3/8"	8/32
	30596	BORB, 143, 195	Metal	96mm c.c.	176 x 35mm	6 15/16" x 1 3/8"	8/32
	305108	195	Metal	108mm c.c.	188 x 35mm	7 3/8" x 1 3/8"	8/32
	305128	BORB, 140, 143, 195	Metal	128mm c.c.	208 x 35mm	8 3/16" x 1 3/8"	8/32
	305192	BORB, 143, 195	Metal	192mm c.c.	272 x 35mm	10 23/32" x 1 3/8"	8/32
	305298	195	Metal	298mm c.c.	378 x 35mm	14 7/8" x 1 3/8"	8/32
	305333	140, 195	Metal	333mm c.c.	413 x 35mm	16 1/4" x 1 3/8"	8/32
	305486	195	Metal	486mm c.c.	566 x 35mm	22 9/32" x 1 3/8"	8/32
	305562	195	Metal	562mm c.c.	642 x 35mm	25 9/32" x 1 3/8"	8/32
	305638	195	Metal	638mm c.c.	718 x 35mm	28 9/32" x 1 3/8"	8/32

REF. NO.	COLOR FINISH	MATERIAL DESCRIPTION	DIMENSION C.C. / Ø	OVERALL DIMENSION (L x P) METRIC	OVERALL DIMENSION (L x P) IMPERIAL	SCREW NAIL	
2	30540	BORB, 143, 195	Metal	40 x 35mm	1 9/16" x 1 3/8"	8/32	
	501696	BORB, 195	Metal	96mm c.c.	136 X 35mm	5 3/8" x 1 3/8"	8/32
3	5016128	BORB, 195	Metal	128mm c.c.	168 x 33mm	6 5/8" x 1 5/16"	8/32
	5016160	BORB, 195	Metal	160mm c.c.	200 x 34mm	7 7/8" x 1 5/16"	8/32
	5016192	BORB, 195	Metal	192mm c.c.	233 x 33mm	9 3/16" x 1 5/16"	8/32



REF. NO.	COLOR FINISH	MATERIAL DESCRIPTION	DIMENSION C.C. / Ø	OVERALL DIMENSION (L x P) METRIC	OVERALL DIMENSION (L x P) IMPERIAL	SCREW NAIL
1	259 130/140, 130/195, 140/11	Brass	96mm c.c.	120 x 30mm	4 23/32" x 1 3/16"	8/32
2	25696 130/195, 140/195	Metal	96mm c.c.	127 x 26mm	5" x 1 1/32"	8/32
3	62196 130, 140	Metal	96mm c.c.	113 x 28mm	4 7/16" x 1 3/32"	M4
4	4443 130, 140	Metal		30 x 33mm	1 3/16" x 1 5/16"	8/32
5	38703 130/30, 130/90	Metal	96mm c.c.	128 x 28mm	5 1/32" x 1 3/32"	8/32
6	3816 130/ 30, 90	Metal	Ø 1 1/4"	32 x 22mm	1 1/4" x 7/8"	8/32
7	00320 140, 174	Metal	Ø 20mm	20 x 23mm	25/32" x 29/32"	8/32
8	6192 140	Metal	Ø 1/2"	12 x 23mm	1/2" x 29/32"	8/32
9	38418 140	Metal	96mm c.c.	110 x 29mm	4 11/32" x 1 5/32"	8/32
10	3687 140	Metal	2" c.c.	69 x 17mm	2 23/32" x 21/32"	8/32
11	842 140, 195	Metal	Ø 22mm	22 x 24mm	7/8" x 15/16"	8/32

REF. NO.	COLOR FINISH	MATERIAL DESCRIPTION	DIMENSION C.C. / Ø	OVERALL DIMENSION (L x P) METRIC	OVERALL DIMENSION (L x P) IMPERIAL	SCREW NAIL
12	090940 195	Metal		40 x 20mm	1 9/16" x 25/32"	8/32
13	31632330 140, 174, 195	Metal		30 x 18mm	1 3/16" x 23/32"	8/32
14	386 184	Metal	16mm c.c.	56 x 25mm	2 7/32" x 1"	8/32
15	22616 182	Metal	Ø 15mm	15 x 23mm	19/32" x 29/32"	M4
16	61636314 195	Metal	14 x 14mm	14 x 22mm	9/16" x 7/8"	M4
17	2813 195, 900	Metal		26 x 20mm	1 1/32" x 25/32"	8/32
18	2881462680 195	Metal	Ø 16mm	16 x 26mm	5/8" x 1 1/32"	8/32
19	1372 140, 195	Metal	Ø 14mm	14 x 25mm	9/16" x 1"	8/32
20	3902 140	Metal	Ø 9/16"	14 x 23mm	9/16" x 29/32"	8/32
21	003015 184, 900	Metal	Ø 15mm	15 x 17mm	19/32" x 21/32"	M4
22	20712 184, 900	Metal	Ø 12mm	12 x 21mm	1/2" x 13/16"	M4



REF. NO.	COLOR FINISH	MATERIAL DESCRIPTION	DIMENSION C.C. / Ø	OVERALL DIMENSION (L x P) METRIC	OVERALL DIMENSION (L x P) IMPERIAL	SCREW NAIL	
1	15400	AE, BORB, ORB, 90, 140, 195	Metal	96mm c.c.	107 x 24mm	4 1/16" x 1 5/16"	8/32
2	4443	BORB, 91, 130, 140, 160, 195, 900, 908	Metal		30 x 33mm	1 3/16" x 1 5/16"	8/32
3	35097	140, 195	Metal	96mm c.c.	103 x 28mm	4 1/16" x 1 3/32"	8/32
4	770	BORB, 130, 140	Metal	Ø 1 1/4"	31 x 29mm	1 1/4" x 1 5/32"	8/32
5	45996	140, 903	Metal	96mm c.c.	107 x 20mm	4 7/32" x 25/32"	M4
6	30843	140, 195, 900	Metal	96mm c.c.	128 x 24mm	5 1/32" x 15/16"	8/32
7	9041	BORB, 140, 195	Metal	Ø 30mm	30 x 37mm	1 3/16" x 1 15/32"	8/32
8	73116	174, 195, 242, 900	Metal	16mm c.c.	44 x 20mm	1 23/32" x 25/32"	8/32
9	491	140, 184	Metal	96mm c.c.	120 x 24mm	4 23/32" x 15/16"	M4

REF. NO.	COLOR FINISH	MATERIAL DESCRIPTION	DIMENSION C.C. / Ø	OVERALL DIMENSION (L x P) METRIC	OVERALL DIMENSION (L x P) IMPERIAL	SCREW NAIL	
10	7289301	195	Metal	36 x 31mm	1 13/32" x 1 7/32"	8/32	
11	2223	175, 184	Metal	3" c.c.	106 x 23mm	4 3/16" x 29/32"	8/32
12	8632	175, 184	Metal	Ø 30mm	30 x 26mm	1 3/16" x 1 1/32"	8/32
13	41296	AE, BORB, 140, 195	Metal	96mm c.c.	111 x 23mm	4 3/8" x 29/32"	8/32
14	0852	195	Metal	96mm c.c.	128 x 27mm	5 1/32" x 1 1/16"	8/32
15	0853	195	Metal	96mm c.c.	134 x 28mm	5 9/32" x 1 3/32"	8/32
16	0851	195	Metal	96mm c.c.	128 x 25mm	5 1/32" x 1"	8/32
17	34553	185	Metal	96mm c.c.	130 x 23mm	5 1/8" x 29/32"	8/32
18	391300	BB, 128, 904	Metal		31 x 22mm	1 7/32" x 7/8"	8/32



REF. NO.	COLOR FINISH	MATERIAL DESCRIPTION	DIMENSION C.C. / Ø	OVERALL DIMENSION (L x P) METRIC	OVERALL DIMENSION (L x P) IMPERIAL	SCREW NAIL
1	6440 130	Metal	64mm c.c.	97 x 19mm	3 13/16" x 3/4"	M4
2	30710 BB, 130	Metal	3" c.c.	128 x 26mm	5 1/32" x 1 1/32"	8/32
3	30740 AE, 130	Metal	3" c.c.	131 x 23mm	5 5/32" x 29/32"	8/32
4	31173 195	Metal	3" c.c.	106 x 25mm	4 3/16" x 1"	8/32
5	760 AE, 195, 903, 991	Metal	3" c.c.	126 x 27mm	4 31/32" x 1 1/16"	8/32
6	761 AE, 195, 903, 991	Metal	3" c.c.	42 x 26mm	1 21/32" x 1 1/32"	8/32
7	36815 BB, 130, 195	Metal	3" c.c.	137 x 25mm	5 13/32" x 1"	8/32
8	37753 130, 140	Metal	Ø 1 1/2"	38 x 18mm	1 1/2" x 23/32"	8/32

REF. NO.	COLOR FINISH	MATERIAL DESCRIPTION	DIMENSION C.C. / Ø	OVERALL DIMENSION (L x P) METRIC	OVERALL DIMENSION (L x P) IMPERIAL	SCREW NAIL
9	37751 130, 140	Metal	Ø 1"	25 x 16mm	1" x 5/8"	8/32
10	476 AE, 130, 140	Metal	Ø 1 1/4"	32 x 22mm	1 1/4" x 7/8"	8/32
11	44630 130, 140, 195	Metal	Ø 30mm	30 x 26mm	1 3/16" x 1 1/32"	8/32
12	36716 BAE, 195	Metal	3" c.c.	130 x 25mm	5 1/8" x 1"	8/32
13	757 195, 909	Metal	Ø 1 3/16"	31 x 27mm	1 3/16" x 1 1/16"	8/32
14	26987 BORB, 195	Metal	128mm c.c.	160 x 31mm	6 5/16" x 1 7/32"	8/32
15	46702 BORB, 195	Metal	32 x 28mm	32 x 28mm	1 1/4" x 1 3/32"	8/32
16	30739 BB, 130, 180	Metal	3" c.c.	105 x 25mm	4 1/8" x 1"	8/32



REF. NO.	COLOR FINISH	MATERIAL DESCRIPTION	DIMENSION C.C. / Ø	OVERALL DIMENSION (L/W x P/H) METRIC	OVERALL DIMENSION (L/W x P/H) IMPERIAL	SCREW NAIL
1	3203	AE Metal	3" c.c.	98 x 18mm	3 27/32" x 23/32"	8/32
2	36220	AE Metal	3" c.c.	132 x 27mm	5 3/16" x 1 1/16"	8/32
3	4450	900, 908 Metal	3" c.c.	86 x 27mm	3 3/8" x 1 1/16"	8/32
4	3713	AE Metal	Ø 1 1/16"	27 x 20mm	1 1/16" x 25/32"	8/32
5	37500	AE, 190 Metal	Ø 42mm	42 x 22mm	1 21/32" x 7/8"	8/32
6	35300	AE, 190 Metal	3" c.c.	126 x 20mm	4 31/32" x 25/32"	8/32
7	39383	AE, 130, 190 Metal	Ø 31mm	31 x 18mm	1 7/32" x 23/32"	8/32
8	37710	AE Metal	Ø 35mm	35 x 21mm	1 3/8" x 13/16"	8/32
9	37200	BB Metal	Ø 1 1/2"	38 x 21mm	1 1/2" x 13/16"	8/32
10	37205	130 Metal	Ø 1 1/2"	38 x 21mm	1 1/2" x 13/16"	8/32
11	37390	BB, 130 Metal	Ø 38mm	38 x 20mm	1 1/2" x 25/32"	8/32
12	37700	AE, 130 Metal	Ø 37mm	37 x 20mm	1 15/32" x 25/32"	8/32
13	37580	BB, 130 Metal	Ø 1 1/2"	38 x 21mm	1 1/2" x 13/16"	8/32

REF. NO.	COLOR FINISH	MATERIAL DESCRIPTION	DIMENSION C.C. / Ø	OVERALL DIMENSION (L/W x P/H) METRIC	OVERALL DIMENSION (L/W x P/H) IMPERIAL	SCREW NAIL
14	3735038	91, 140, 195, 903 Metal	Ø 38mm	38 x 26mm	1 1/2" x 1 1/32"	8/32
15	476	193 Metal	Ø 1 1/4"	32 x 22mm	1 1/4" x 7/8"	8/32
16	30737	130 Metal	3" c.c.	124 x 23mm	4 7/8" x 29/32"	8/32
17	38195	130 Metal	Ø 35mm	35 x 19mm	1 3/8" x 3/4"	8/32
18	37585	AE, 130, 193 Metal	Ø 39mm	39 x 20mm	1 17/32" x 25/32"	8/32
19	30229	AE, 130, 193 Metal	3" c.c.	104 x 29mm	4 3/32" x 1 5/32"	8/32
20	35730	AE, 130 Metal	3" c.c.	140 x 24mm	5 1/2" x 15/16"	8/32
21	30175	AE, 130 Metal		20 x 48mm	25/32" x 1 7/8"	8/32
22	36632	AE, 91, 130, 140 Metal	3" c.c.	86 x 23mm	3 3/8" x 29/32"	8/32
23	0218	140, 195 Metal	Ø 28mm	28 x 24mm	1 3/32" x 15/16"	8/32
24	30271	AE, 130, 190 Metal	Ø 38mm	12 x 38mm	15/32" x 1 1/2"	8/32
25	30942	AE Metal	Ø 38mm	38 x 9mm	1 1/2" x 11/32"	8/32
26	34127	AE, 130 Metal	3" c.c.	117 x 19mm	4 19/32" x 3/4"	8/32





REF. NO.	COLOR FINISH	MATERIAL DESCRIPTION	DIMENSION C.C. / Ø	OVERALL DIMENSION METRIC	OVERALL DIMENSION (L x P) IMPERIAL	SCREW NAIL
1	82333 BB, ORB, 193, 195, 908	Metal	3" c.c.	125 x 25mm	4 29/32" x 1"	8/32
2	30342 BB, ORB, 142, 193, 195, 908	Metal	64mm c.c.	104 x 25mm	4 3/32" x 1"	8/32
3	410128 BB, 142, 193, 908	Metal	128mm c.c.	147 x 35mm	5 3/4" x 1 3/8"	8/32
4	2920 BB, ORB, BORB, 142, 193, 908	Metal	Ø 32mm	32 x 28mm	1 1/4" x 1 3/32"	8/32
5	82905128 BB, 193, 908	Metal	128mm c.c.	156 x 27mm	6 5/32" x 1 1/16"	8/32
6	770 BORB, 140, 195, 907	Metal	Ø 1 1/4"	32 x 27mm	1 1/4" x 1 1/16"	8/32

REF. NO.	COLOR FINISH	MATERIAL DESCRIPTION	DIMENSION C.C. / Ø	OVERALL DIMENSION METRIC	OVERALL DIMENSION (L x P) IMPERIAL	SCREW NAIL
7	288996 BB, ORB, BORB, 142, 180, 193, 195, 908	Metal	96mm c.c.	165 x 24mm	6 1/2" x 15/16"	8/32
8	10734 BB, ORB, BORB, 114, 142, 193, 195, 900, 908	Metal	Ø 34mm	34 x 25mm	1 11/32" x 1"	8/32
9	5183 BB, ORB, BORB, 114, 142, 193, 195, 908	Metal	3" c.c.	132 x 25mm	5 3/16" x 1"	8/32
	5196 BORB, 142, 195	Metal	96mm c.c.	153 x 26mm	6" x 1"	8/32
10	39770 185, 193	Metal	Ø 31mm	31 x 65mm	1 7/32" x 2 9/16"	8/32



REF. NO.	COLOR FINISH	MATERIAL DESCRIPTION	DIMENSION C.C. / Ø	OVERALL DIMENSION METRIC	OVERALL DIMENSION (L x P) IMPERIAL	SCREW NAIL
1	AE, BORB, 142, 195	Metal	256mm c.c.	311 x 44mm	12 1/4" x 1 11/16"	8/32
2	AE*, BORB, 91, 142*, 163*, 193*, 195, 900, 908	Metal	96mm c.c	132 x 24mm	5 3/16" x 15/16"	8/32 *M4
3	AE, BORB, 142, 163, 193*, 195	Metal	Ø 30mm	30 x 29mm	1 3/16" x 1 5/32"	8/32 *M4
4	BORB, R3, 195, 908	Metal	256mm c.c.	306 x 47mm	12" x 1 7/8"	8/32
5	BORB, R3, 195, 908	Metal	96mm c.c	140 x 26mm	5 1/2" x 1 1/32"	M4
6	BORB, R3, 195, 908	Metal	Ø 30mm	30 x 23mm	1 3/16" x 29/32"	M4

REF. NO.	COLOR FINISH	MATERIAL DESCRIPTION	DIMENSION C.C. / Ø	OVERALL DIMENSION METRIC	OVERALL DIMENSION (L x P) IMPERIAL	SCREW NAIL
7	BB, 908	Metal	160mm c.c.	180 x 28mm	7 3/32" x 1 3/32"	8/32
8	908	Metal	Ø 38mm	38 x 32mm	1 1/2" x 1 1/4"	8/32
9	BB, BORB, 142, 195	Metal	128mm c.c.	158 x 27mm	6 7/32" x 1 1/16"	M4
10	BB, BORB, 193, 908	Metal	32 x 32mm	32 x 32mm	1 1/4" x 1 1/4"	8/32
11	142	Metal	128mm c.c.	153 x 29mm	6 1/32" x 1 5/32"	M4
12	BB, 142, 195	Metal	Ø 32mm	32 x 28mm	1 1/4" x 1 3/32"	M4
13	AE, 142, 163, 193, 91	Metal	64mm c.c.	79 x 22mm	3 1/8" x 7/8"	8/32





REF. NO.	COLOR FINISH	MATERIAL DESCRIPTION	DIMENSION C.C. / Ø	OVERALL DIMENSION (L x P) METRIC	OVERALL DIMENSION (L x P) IMPERIAL	SCREW NAIL
1	391456 BB, 128, 193, 903, 904	Metal	Ø 30mm	30 x 21mm	1 3/16" x 13/16"	8/32
2	391455 BB, 128, 193, 903, 904	Metal	3" c.c.	104 x 30mm	4 3/32" x 1 3/16"	8/32
3	391439 BB, 128, 193, 903, 904	Metal	96mm c.c.	107 x 28mm	4 7/32" x 1 3/32"	8/32
4	391440 BB, 128, 193, 903, 904	Metal	35mm c.c.	46 x 24mm	1 3/8" x 15/16"	8/32
5	391204 BB, 128, 193, 903, 904	Metal	Ø 30mm	30 x 27mm	1 3/16" x 1 1/16"	8/32

REF. NO.	COLOR FINISH	MATERIAL DESCRIPTION	DIMENSION C.C. / Ø	OVERALL DIMENSION (L x P) METRIC	OVERALL DIMENSION (L x P) IMPERIAL	SCREW NAIL
6	391203 BB, 128, 193, 903, 904	Metal	3" c.c.	102 x 22mm	4 1/32" x 7/8"	8/32
7	391462 BB, 128, 193, 903, 904	Metal	96mm c.c.	120 x 22mm	4 23/32" x 7/8"	8/32
8	391460 BB, 128, 193, 903, 904	Metal	Ø 31mm	31 x 23mm	1 7/32" x 29/32"	8/32
9	391459 BB, 128, 193, 903, 904	Metal	3" c.c.	99 x 29mm	3 29/32" x 1 5/32"	8/32



REF. NO.	COLOR FINISH	MATERIAL DESCRIPTION	DIMENSION C.C. / Ø	OVERALL DIMENSION (L x P)		SCREW NAIL
				METRIC	IMPERIAL	
1	391299	BB, 128, 193, 195, 903, 904	Metal	49 x 31mm	1 15/16" x 1 7/32"	8/32
2	391458	BB, 128, 193, 195, 903, 904	Metal	128mm c.c.	157x 26mm 6 3/16" x 1 1/32"	8/32
3	391371	BB, 128, 193, 195, 903, 904	Metal	96mm c.c.	117 x 27mm 4 19/32" x 1 1/16"	8/32

REF. NO.	COLOR FINISH	MATERIAL DESCRIPTION	DIMENSION C.C. / Ø	OVERALL DIMENSION (L x P)		SCREW NAIL
				METRIC	IMPERIAL	
4	391356	BB, 128, 193, 195, 903, 904	Metal	28 x 23mm	1 3/32" x 29/32"	8/32
5	391210	BB, 128, 193, 903, 904	Metal	Ø 31mm	31 x 28mm 1 7/32" x 1 3/32"	8/32
6	391480	BB, 128, 193, 903, 904	Metal	96mm c.c.	122 x 26mm 4 13/16" x 1 1/32"	8/32
7	391211	BB, 128, 193, 903, 904	Metal	3" c.c.	103 x 26mm 4 1/16" x 1 1/32"	8/32





REF. NO.	COLOR FINISH	MATERIAL DESCRIPTION	DIMENSION C.C. / Ø	OVERALL DIMENSION METRIC	OVERALL DIMENSION IMPERIAL (L x P/H)	SCREW NAIL
1	10138 AE, 900, 904	Metal	Ø 38mm	38 x 58mm	1 1/2" x 2 9/32"	8/32
2	10134 AE, 900, 904	Metal	Ø 30mm	30 x 52mm	1 3/16" x 2 1/16"	8/32
3	10238 AE, ORB, 900, 904	Metal	Ø 38mm	38 x 33mm	1 1/2" x 1 5/16"	8/32
4	106100 AE, 900, 904	Metal	100mm c.c.	110 x 43mm	4 11/32" x 1 11/16"	8/32
5	10696 AE, ORB, 900, 904	Metal	96mm c.c.	106 x 43mm	4 3/16" x 1 11/16"	8/32
6	104224 AE, ORB, 900, 904	Metal	224mm c.c.	250 x 46mm	9 27/32" x 1 13/16"	8/32
7	104160 AE, 900, 904	Metal	160mm c.c.	185 x 46mm	7 9/32" x 1 13/16"	8/32

REF. NO.	COLOR FINISH	MATERIAL DESCRIPTION	DIMENSION C.C. / Ø	OVERALL DIMENSION METRIC	OVERALL DIMENSION IMPERIAL (L x P/H)	SCREW NAIL
8	104128 AE, 900, 904	Metal	128mm c.c.	150 x 46mm	5 29/32" x 1 13/16"	8/32
9	10496 AE, 900, 904	Metal	96mm c.c.	120 x 46mm	4 23/32" x 1 13/16"	8/32
10	10569 AE, 900, 904	Metal	69 x 23mm		2 23/32" x 29/32"	8/32
11	10555 AE, ORB, 900, 904	Metal	55 x 20mm		2 5/32" x 25/32"	8/32
12	767160 R3, 908	Metal	160mm c.c.	170 x 35mm	6 11/16" x 1 3/8"	M4
13	767128 R3, 908	Metal	128mm c.c.	138 x 35mm	5 7/16" x 1 3/8"	M4
14	74958 R3, 908	Metal	58 x 38mm		2 9/32" x 1 1/2"	M4





REF. NO.	COLOR FINISH	MATERIAL DESCRIPTION	DIMENSION C.C. / Ø	OVERALL DIMENSION (L x P) METRIC	OVERALL DIMENSION (L x P) IMPERIAL	SCREW NAIL
1	512186 BB, ORB, BORB, 193, 800, 900, 903	Metal	6" c.c.	173 x 38mm	6 13/16" x 1 1/2"	8/32
2	5121812 BB, ORB, BORB, 193, 800, 900, 903	Metal	12" c.c.	323 x 38mm	12 23/32" x 1 1/2"	8/32
3	511193 BB, ORB, BORB, 193, 800, 900, 903	Metal		93 x 42mm	3 11/16" x 7/8"	8/32

REF. NO.	COLOR FINISH	MATERIAL DESCRIPTION	DIMENSION C.C. / Ø	OVERALL DIMENSION (L x P) METRIC	OVERALL DIMENSION (L x P) IMPERIAL	SCREW NAIL
4	8061865 AE, BB, ORB, BORB, 193, 195, 900, 903, 908	Metal		65 x 31mm	2 9/16" x 7/8"	8/32
5	80718128 AE, BB, ORB, BORB, 193, 195, 900, 903, 908	Metal	128mm c.c.	145 x 35mm	5 23/32" x 7/8"	8/32
6	82718 AE, BORB, 195	Metal	12" c.c.	338 x 55mm	13 5/16" x 2 5/32"	8/32



REF. NO.	COLOR FINISH	MATERIAL DESCRIPTION	DIMENSION C.C. / Ø	OVERALL DIMENSION (L x P) METRIC	OVERALL DIMENSION (L x P) IMPERIAL	SCREW NAIL
1	23738192 BB, BORB, 195, 801, 906, 907	Metal	192mm c.c.	208 x 33mm	8 3/16" x 1 1/4"	8/32
2	23738128 BB, BORB, 195, 801, 906, 907	Metal	128mm c.c.	145 x 31mm	4 3/8" x 1 3/16"	8/32
3	2373896 BB, BORB, 195, 801, 906, 907	Metal	96mm c.c.	109 x 27mm	4 9/32" x 1 1/16"	8/32
4	23737192 BB, BORB, 195, 801, 906, 907	Metal	192mm c.c.	208 x 33mm	8 3/16" x 1 1/4"	8/32
5	23737128 BB, BORB, 195, 801, 906, 907	Metal	128mm c.c.	146 x 31mm	4 3/8" x 1 3/16"	8/32

REF. NO.	COLOR FINISH	MATERIAL DESCRIPTION	DIMENSION C.C. / Ø	OVERALL DIMENSION (L x P) METRIC	OVERALL DIMENSION (L x P) IMPERIAL	SCREW NAIL
6	2373796 BB, BORB, 195, 801, 906, 907	Metal	96mm c.c.	110 x 30mm	4 5/16" x 1 3/16"	8/32
7	2391533 BB, BORB, 195, 801, 906, 907	Metal	Ø 33mm	33 x 26mm	1 5/16" x 1 1/32"	8/32
8	2391528 BB, BORB, 195, 801, 906, 907	Metal	Ø 28mm	28 x 24mm	1 3/32" x 15/16"	8/32
9	2391132 BB, BORB, 195, 801, 906, 907	Metal	Ø 32mm	32 x 24mm	1 1/4" x 15/16"	8/32



REF. NO.	COLOR FINISH	MATERIAL DESCRIPTION	DIMENSION C.C. / Ø	OVERALL DIMENSION METRIC	OVERALL DIMENSION (L x P) IMPERIAL	SCREW NAIL
1	236796 BB, BORB, 195, 801, 906, 907	Metal	96mm c.c.	117 x 30mm	4 19/32" x 1 13/16"	8/32
2	2390332 BB, BORB, 195, 801, 906, 907	Metal	Ø 32mm	32 x 21mm	1 1/4" x 13/16"	8/32
3	2381964 BB, BORB, 195, 801, 906, 907	Metal	64mm c.c.	77 x 55mm	3 1/32" x 2 5/32"	M4
4	2391632 BB, BORB, 195, 801, 906, 907	Metal	Ø 32mm	32 x 27mm	1 1/4" x 1 1/16"	M4

REF. NO.	COLOR FINISH	MATERIAL DESCRIPTION	DIMENSION C.C. / Ø	OVERALL DIMENSION METRIC	OVERALL DIMENSION (L x P) IMPERIAL	SCREW NAIL
5	23613 BB, BORB, 801, 907	Metal	Ø 25mm	85 x 22mm	3 11/32" x 7/8"	M4
6	23601 BB, BORB, 195, 801, 906, 907	Metal	Ø 25mm	99 x 25mm	3 29/32" x 1"	M4
7	2374196 BB, BORB, 195, 801, 906, 907	Metal	96mm c.c.	105 x 17mm	4 1/8" x 21/32"	M4
8	2392010 BB, BORB, 195, 801, 906, 907	Metal	Ø 10mm	10 x 21mm	13/32" x 13/16"	M4



REF. NO.	COLOR FINISH	MATERIAL DESCRIPTION	DIMENSION C.C. / Ø	OVERALL DIMENSION (L x P) METRIC	OVERALL DIMENSION (L x P) IMPERIAL	SCREW NAIL
1	2321764 900, 908	Metal	64mm c.c.	89 x 27mm	3 1/2" x 1 1/16"	M4
2	23218128 900, 908	Metal	128mm c.c.	177 x 34mm	6 31/32" x 1 11/32"	M4
3	2321896 900, 908	Metal	96mm c.c.	145 x 35mm	5 23/32" x 1 3/8"	M4
4	2395333 900, 908	Metal	Ø 33mm	33 x 30mm	1 5/16" x 1 3/16"	M4
5	23216 900, 908	Metal		52 x 33mm	2 1/16" x 1 5/16"	M4
6	8575576 HB, HC, HI	Metal	96mm c.c.	110 x 28mm	4 5/16" x 1 3/32"	8/32
7	852243 HB, HC, HI	Metal		43 x 27mm	1 11/16" x 1 1/16"	8/32
8	852436 HB, HC, HI	Metal		36 x 27mm	1 13/32" x 1 1/16"	8/32
9	852336 HB, HC, HI	Metal		36 x 27mm	1 13/32" x 1 1/16"	8/32
10	11804 90	Metal	105mm c.c.	133 x 33mm	5 1/4" x 1 5/16"	Wood screw

REF. NO.	COLOR FINISH	MATERIAL DESCRIPTION	DIMENSION C.C. / Ø	OVERALL DIMENSION (L x P) METRIC	OVERALL DIMENSION (L x P) IMPERIAL	SCREW NAIL
11	5120430 802, 900, 908	Metal	Ø 30mm	30 x 30mm	1 3/16" x 1 3/16"	8/32
12	5120435 802, 900, 908	Metal	Ø 35mm	35 x 35mm	1 3/8" x 1 3/8"	8/32
13	1218 906	Metal	50mm c.c.	40 x 70mm	1 9/16" x 2 3/4"	No. 6
14	1203 906	Metal	24mm c.c.	48 x 60mm	1 7/8" x 2 3/8"	No. 6
15	1244 906	Metal		41 x 68mm	1 5/8" x 2 11/16"	No. 6
16	1226 906	Metal	85mm c.c.	118 x 19mm	4 21/32" x 3/4"	No. 6
17	1031 906	Metal	81mm c.c.	110 x 25mm	4 11/32" x 1"	M4
18	2053 M41, 90	Metal	2 3/8" c.c.	52 x 88mm	2 1/16" x 3 15/32"	Wood screw
19	2056 M41, 90	Metal	Ø 1 1/16"	28 x 19mm	1 1/16" x 3/4"	8/32
20	2057 M41, 90	Metal	3 1/4" c.c.	130 x 25mm	5 1/8" x 1"	Wood screw

Nails and screws: see p.121



REF. NO.	COLOR FINISH	MATERIAL DESCRIPTION	DIMENSION C.C. / Ø	OVERALL DIMENSION (L x P)		SCREW NAIL
				METRIC	IMPERIAL	
1	2514138	903	Metal	38 x 24mm	1 1/2" x 15/16"	8/32
2	255332	903	Metal	29 x 26mm	1 5/32" x 1 1/32"	8/32
3	25142128	903	Metal	128mm c.c.	141 x 25mm	5 9/16" x 1"
4	2514296	903	Metal	96mm c.c.	109 x 25mm	4 9/32" x 1"
5	2525128	195, 903	Metal	128mm c.c.	146 x 25mm	5 3/4" x 1"

REF. NO.	COLOR FINISH	MATERIAL DESCRIPTION	DIMENSION C.C. / Ø	OVERALL DIMENSION (L x P)		SCREW NAIL
				METRIC	IMPERIAL	
6	252596	195, 903	Metal	96mm c.c.	115 x 25mm	4 17/32" x 1"
7	253796	195, 903	Metal	96mm c.c.	135 x 22mm	5 5/16" x 7/8"
8	2537024	195, 903	Metal	24 x 24mm	24 x 21mm	15/16" x 13/16"
9	2537018	195, 903	Metal	18 x 18mm	18 x 20mm	23/32" x 25/32"





REF. NO.	COLOR FINISH	MATERIAL DESCRIPTION	DIMENSION C.C. / Ø	OVERALL DIMENSION (L x P) METRIC	OVERALL DIMENSION (L x P) IMPERIAL	SCREW NAIL
1	26956 AE, 142, 184	Metal	96mm c.c.	115 x 25mm	4 17/32" x 1"	M4
2	46853 AE, 142, 184	Metal	Ø 32mm	32 x 25mm	1 1/4" x 1"	8/32
3	26957 AE, 142	Metal	96mm c.c.	126 x 24mm	4 31/32" x 15/16"	M4
4	26985 AE, 142	Metal		20 x 65mm	25/32" x 2 9/16"	M4
5	26959 AE, 142, 193	Metal	96mm c.c.	127 x 27mm	5" x 1 1/16"	M4
6	26953 AE, 142, 184	Metal	64mm c.c.	87 x 29mm	3 7/16" x 1 5/32"	M4

REF. NO.	COLOR FINISH	MATERIAL DESCRIPTION	DIMENSION C.C. / Ø	OVERALL DIMENSION (L x P) METRIC	OVERALL DIMENSION (L x P) IMPERIAL	SCREW NAIL
7	26954 AE	Metal		17 x 95mm	21/32" x 3 3/4"	M4
8	26955 AE	Metal	64mm c.c.	95 x 18mm	3 3/4" x 23/32"	M4
9	2692996 BB, 142	Metal	96mm c.c.	115 x 24mm	4 17/32" x 15/16"	8/32
10	46851 AE, 142	Metal	Ø 32mm	32 x 28mm	1 1/4" x 1 3/32"	M4
11	26951 AE, 142	Metal	96mm c.c.	119 x 24mm	4 11/16" x 15/16"	M4



REF. NO.	COLOR FINISH	MATERIAL DESCRIPTION	DIMENSION C.C. / Ø	OVERALL DIMENSION (L x P) METRIC	OVERALL DIMENSION (L x P) IMPERIAL	SCREW NAIL
1	750 BB, 908, 909	Metal	4 1/4" c.c.	124 x 38mm	4 7/8" x 1 1/2"	8/32
2	751 BB, 908, 909	Metal	4 1/4" c.c.	38 x 124mm	1 1/2" x 4 7/8"	8/32
3	473 AE, BB, 908, 909	Metal	3" c.c.	142 x 30mm	5 19/32" x 1 3/16"	8/32
4	670 BB, 908, 909	Metal	Ø 1 1/4"	32 x 28mm	1 1/4" x 1 3/32"	8/32
5	30214 909	Metal	4 1/4" c.c.	143 x 21mm	5 5/8" x 13/16"	8/32
6	30219 909	Metal	3 1/4" c.c.	115 x 21mm	4 17/32" x 13/16"	8/32
7	668 908, 909	Metal	Ø 1 1/4"	32 x 26mm	1 1/4" x 1 1/32"	8/32
8	757 802, 908	Metal	Ø 1 3/16"	30 x 27mm	1 3/16" x 1 1/16"	8/32
9	475 908, 909	Metal	Ø 1 1/8"	28 x 22mm	1 1/8" x 7/8"	8/32
10	46700 AE	Metal plate & knob		102 x 23mm	4 1/32" x 29/32"	Nail

REF. NO.	COLOR FINISH	MATERIAL DESCRIPTION	DIMENSION C.C. / Ø	OVERALL DIMENSION (L x P) METRIC	OVERALL DIMENSION (L x P) IMPERIAL	SCREW NAIL	
11	874 AE	Metal	Ø 1 1/8"	28 x 18mm	1 1/8" x 23/32"	8/32	
12	30755 AE	Metal	3 1/2" c.c.	124 x 28mm	4 7/8" x 1 3/32"	8/32	
13	30745 AE	Metal	3" c.c.	112 x 33mm	4 13/32" x 1 5/16"	8/32	
14	96141 136, 805, 908	Metal	Ø 41mm	41 x 21mm	1 5/8" x 13/16"	8/32	
15	667 BB, 908, 909	Metal	96mm c.c.	142 x 30mm	5 19/32" x 1 3/16"	8/32	
16	665 BB, 908, 909	Metal		74 x 27mm	2 29/32" x 1 1/16"	8/32	
17	30188 909	Metal	Ø 44mm	44 x 29mm	1 23/32" x 1 5/32"	8/32	
18	37160 909	Metal	Ø 34mm	34 x 26mm	1 11/32" x 1 1/32"	8/32	
19	741 909	Metal		25 x 72mm	1" x 2 13/16"	8/32	
20	731 909	Metal		96mm c.c.	106 x 35mm	4 3/16" x 1 3/8"	8/32





REF. NO.	COLOR FINISH	MATERIAL DESCRIPTION	DIMENSION C.C. / Ø	OVERALL DIMENSION (L x P) METRIC	OVERALL DIMENSION (L x P) IMPERIAL	SCREW NAIL
1	3802 BB/ 364, 365, 366	Metal & ceramic	3" c.c.	127 x 31mm	5" x 1 7/32"	8/32
2	3816 BB/ 364, 365, 366	Metal & ceramic	Ø 1 1/4"	32 x 22mm	1 1/4" x 7/8"	8/32
3	3802 195/ 364, 365, 366	Metal & ceramic	3" c.c.	127 x 31mm	5" x 1 7/32"	8/32
4	3816 195/ 364, 365, 366	Metal & ceramic	Ø 1 1/4"	32 x 22mm	1 1/4" x 7/8"	8/32
5	63105 364, 365, 366	Ceramic	Ø 31mm	31 x 25mm	1 7/32" x 1"	M4
6	284 BB	Metal plate		132 x 30mm	5 3/16" x 1 3/16"	Nail
7	3380 89	Metal & ceramic	Ø 1"	25 x 20mm	1" x 25/32"	8/32
8	861 BB	Metal & ceramic	3" c.c.	126 x 23mm	4 31/32" x 29/32"	8/32
9	3802 BB/89	Metal & ceramic	3" c.c.	127 x 31mm	5" x 1 7/32"	8/32
10	3381 30, 40	Ceramic	Ø 1 1/4"	32 x 25mm	1 1/4" x 1"	8/32
11	521 304	Ceramic	Ø 38mm	38 x 27mm	1 1/2" x 1 1/16"	8/32
12	522 304	Ceramic	Ø 32mm	32 x 24mm	1 1/4" x 15/16"	8/32
13	6005 30	Ceramic	Ø 34mm	34 x 31mm	1 11/32" x 1 7/32"	8/32
14	1322 30	Ceramic	Ø 1 3/8"	35 x 29mm	1 3/8" x 1 5/32"	8/32
15	33672 30, 40, 41, 90	Ceramic	Ø 1 3/8"	35 x 29mm	1 3/8" x 1 5/32"	8/32

REF. NO.	COLOR FINISH	MATERIAL DESCRIPTION	DIMENSION C.C. / Ø	OVERALL DIMENSION (L x P) METRIC	OVERALL DIMENSION (L x P) IMPERIAL	SCREW NAIL
16	6006 58, 61, 62	Ceramic	Ø 38mm	38 x 25mm	1 1/2" x 1"	8/32
17	60037 308	Ceramic	Ø 37mm	37 x 26mm	1 15/32" x 1 1/32"	8/32
18	60031 308	Ceramic	Ø 31mm	31 x 23mm	1 7/32" x 29/32"	8/32
19	33612 1266, 363	Ceramic	Ø 1 3/8"	35 x 27mm	1 3/8" x 1 1/16"	8/32
20	235022 30	Ceramic	Ø 34mm	34 x 30mm	1 11/32" x 1 3/16"	8/32
21	74526 30	Ceramic		34 x 26mm	1 11/32" x 1 1/32"	8/32
22	23150 30	Ceramic	Ø 52mm	52 x 23mm	2 1/16" x 29/32"	8/32
23	142 30/130	Ceramic	Ø 1 1/2"	38 x 27mm	1 1/2" x 1 1/16"	8/32
24	6010 30	Ceramic	Ø 1 3/8"	35 x 28mm	1 3/8" x 1 1/32"	8/32
25	6004 30	Ceramic	Ø 7/8"	22 x 25mm	7/8" x 1"	8/32
26	6006 30	Ceramic	Ø 38mm	38 x 26mm	1 1/2" x 1 1/32"	8/32
27	3385 30	Ceramic	Ø 1 1/4"	32 x 26mm	1 1/4" x 1 1/32"	8/32
28	60037 325, 326, 327	Ceramic	Ø 37mm	37 x 26mm	1 15/32" x 1 1/32"	8/32
29	60125 370, 371, 372, 373	Ceramic	Ø 40mm	40 x 26mm	1 9/16" x 1 1/32"	8/32



REF. NO.	COLOR FINISH	MATERIAL DESCRIPTION	DIMENSION C.C. / Ø	OVERALL DIMENSION (L x P) METRIC	OVERALL DIMENSION (L x P) IMPERIAL	SCREW NAIL	
1	38096	BB/30, 195/30, 801/30, 906/30, 907/30	Metal & ceramic	96mm c.c.	150 x 35mm	5 29/32" x 1 3/8"	8/32
2	415	AE/30	Metal & ceramic	3" c.c.	123 x 32mm	4 13/16" x 1 1/4"	8/32
3	981	145	Metal	3" c.c.	114 x 25mm	4 1/2" x 1"	8/32
4	3801	BB/250, BB/251	Metal & wood	3" c.c.	127 x 31mm	5" x 1 7/32"	8/32
5	412	195/15.1	Metal & wood	3" c.c.	127 x 31mm	5" x 1 7/32"	8/32
6	3802	130/30, 130/40, 140/30, 195/30	Metal & ceramic	3" c.c.	127 x 31mm	5" x 1 7/32"	8/32
7	3816	195/30	Metal & ceramic	Ø 1 1/4"	32 x 24mm	1 1/4" x 15/16"	8/32
8	420	195/15.1	Metal & wood	Ø 1 1/4"	32 x 26mm	1 1/4" x 1 1/32"	8/32
9	9700	BB/30, 195/30, 801/30, 906/30, 907/30	Metal & ceramic	96mm c.c.	111 x 32mm	4 3/8" x 1 1/4"	M4

REF. NO.	COLOR FINISH	MATERIAL DESCRIPTION	DIMENSION C.C. / Ø	OVERALL DIMENSION (L x P) METRIC	OVERALL DIMENSION (L x P) IMPERIAL	SCREW NAIL	
10	5003	30	Metal & ceramic	Ø 1"	25 x 24mm	1" x 15/16"	8/32
11	4418	195/304	Metal & ceramic	Ø 1 1/4"	32 x 24mm	1 1/4" x 15/16"	8/32
12	7014128	140/30	Metal & ceramic	128mm c.c.	138 x 27mm	5 7/16" x 1 1/16"	M4
13	97960	140/30	Metal & ceramic	60 x 24mm	2 3/8" x 15/16"	M4	
14	1418	130/30, 140/30	Brass & ceramic	Ø 1 1/4"	32 x 25mm	1 1/4" x 1"	8/32
15	1417	130/30, 140/30	Brass & ceramic	3" c.c.	91 x 32mm	3 19/32" x 1 1/4"	8/32
16	76246	140/30	Metal & ceramic	Ø 1 1/4"	32 x 26mm	1 1/4" x 1 1/32"	8/32
17	33477	130/304, 195/304	Metal & ceramic	Ø 32mm	32 x 24mm	1 1/4" x 15/16"	8/32



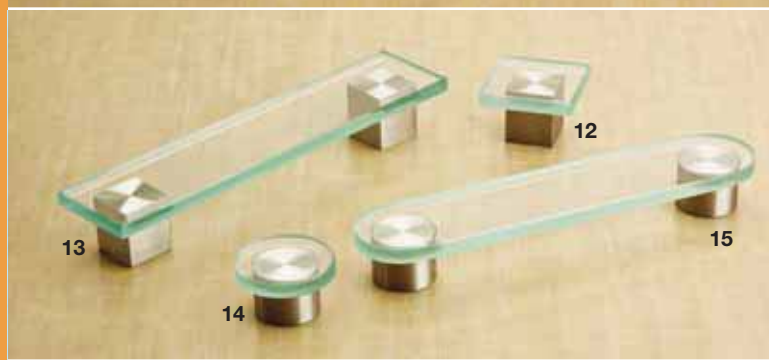

REF. NO.	COLOR FINISH	MATERIAL DESCRIPTION	DIMENSION C.C. / Ø	OVERALL DIMENSION (L x P) METRIC	OVERALL DIMENSION (L x P) IMPERIAL	SCREW NAIL
1	10083	BORB/11, 140/11, 184/11, Metal & glass	3" c.c.	96 x 42mm	3 3/4" x 1 21/32"	8/32
2	10082	BORB/11, 140/11, 184/11, Metal & glass	3" c.c.	96 x 42mm	3 3/4" x 1 21/32"	8/32
3	10074	BORB/11, 140/11, 184/11, Metal & glass	Ø 33mm	33 x 30mm	1 9/32" x 1 3/16"	8/32
4	3922	AE, 130, 140, 175, 195, 130/30, Metal & porcelain	Ø 1 1/4"	43 x 41mm	1 11/16" x 1 5/8"	8/32
5	T9148	130/30, Porcelain	Ø 36mm	36 x 39mm	1 13/32" x 1 17/32"	8/32
6	460	130, 195, Metal plate	Ø 33mm	33 x 35mm	1 5/16" x 1 3/8"	8/32
7	16063244	BB, Metal & acrylic Metal plate	Ø 33mm Ø 45mm	33 x 34mm	1 9/32" x 1 11/32"	8/32
8	T9148	130/11, Crystal & 24K Gold	Ø 36mm	36 x 39mm	1 13/32" x 1 17/32"	8/32
9	10080	195/11, Metal & acrylic	Ø 32mm	32 x 36mm	1 1/4" x 1 3/8"	8/32
10	10085	195/11, Metal & acrylic	Ø 32mm	32 x 36mm	1 1/4" x 1 3/8"	8/32

REF. NO.	COLOR FINISH	MATERIAL DESCRIPTION	DIMENSION C.C. / Ø	OVERALL DIMENSION (L x P) METRIC	OVERALL DIMENSION (L x P) IMPERIAL	SCREW NAIL
11	4035	AE/11, BORB/11, 11, 140/11, 184/11, Brass & acrylic	Ø 28mm	28 x 38mm	1 3/32" x 1 1/2"	8/32
12	482548	195/11, Metal & glass	48 x 48mm	48 x 32mm	1 7/8" x 1 1/4"	8/32
13	4825160	195/11, Metal & glass	160mm c.c.	208 x 32mm	8 3/16" x 1 1/4"	8/32
14	453045	195/11, Metal & glass	Ø 45mm	45 x 27mm	1 25/32" x 1 1/16"	8/32
15	4530160	195/11, Metal & glass	160mm c.c.	205 x 27mm	8 1/16" x 1 1/16"	8/32
16	D010201	Acrylic	127 x 45mm	5" x 1 3/4"		Self-adhesive
17	500	11, Acrylic	45 x 45mm	1 3/4" x 1 3/4"		Self-adhesive
18	507	11, Acrylic	Ø 1 7/8"	48 x 30mm	1 7/8" x 1 3/16"	Self-adhesive
19	503	11, Acrylic	Ø 1 7/8"	48 x 30mm	1 7/8" x 1 3/16"	Self-adhesive
20	808	11, Acrylic	76 x 25mm	3" x 1"		Self-adhesive
21	D032015	sold as a pair, Stainless steel	Ø 16mm	16 x 20mm	5/8" x 25/32"	Glue on glass
22	83212*	170, Stainless steel	Ø 16mm	16 x 6mm	5/8" x 1/4"	8/32
23	M412*	170, Stainless steel	Ø 16mm	16 x 6mm	5/8" x 1/4"	M4

\* Glue on glass base for knob or pull



REF. NO.	COLOR FINISH	MATERIAL DESCRIPTION	DIMENSION C.C. / Ø	OVERALL DIMENSION (L x P) METRIC	OVERALL DIMENSION (L x P) IMPERIAL	SCREW NAIL
1	6110 30, 90	Plastic	96mm c.c.	103 x 29mm	4 1/16" x 1 5/32"	No. 6
2	3130 30, 90	Plastic	96mm c.c.	105 x 30mm	4 1/8" x 1 3/16"	No. 6
3	3133 30, 90	Plastic	3" c.c.	83 x 30mm	3 9/32" x 1 3/16"	No. 6
4	6120 30, 90	Plastic	4" c.c.	42 x 29mm	1 21/32" x 1 5/32"	No. 6
5	SP390 02, 03, 11	Plastic	Ø 38mm	38 x 26mm	1 1/2" x 1 1/32"	No. 6
6	74496 140, 145	Plastic	96mm c.c.	118 x 24mm	4 5/8" x 1"	M4
7	62430 140, 145	Plastic	30mm c.c.	30 x 28mm	1 3/16" x 1 3/32"	M4
8	32328 185	Plastic	128mm c.c.	142 x 28mm	5 19/32" x 1 3/32"	No. 6
9	33841 185	Plastic		38 x 25mm	1 1/2" x 1"	No. 6
10	33353 185	Plastic	Ø 34mm	34 x 27mm	1 11/32" x 1 1/16"	No. 6

REF. NO.	COLOR FINISH	MATERIAL DESCRIPTION	DIMENSION C.C. / Ø	OVERALL DIMENSION (L x P) METRIC	OVERALL DIMENSION (L x P) IMPERIAL	SCREW NAIL
11	32323 185	Plastic	96mm c.c.	127 x 27mm	5" x 1 1/16"	No. 6
12	3140 30, 90	Plastic	Ø 1 1/4"	32 x 27mm	1 1/4" x 1 1/16"	No. 6
13	809096 140, 145	Plastic	96mm c.c.	114 x 22mm	4 1/2" x 7/8"	M4
14	62431 140, 145	Plastic	30mm c.c.	30 x 28mm	1 3/16" x 1 3/32"	M4
15	934900 Baseball	Polyester	Ø 34mm	34 x 34mm	1 11/32" x 1 11/32"	8/32
16	935000 Basketball	Polyester	Ø 34mm	34 x 34mm	1 11/32" x 1 11/32"	8/32
17	935100 Tennis	Polyester	Ø 34mm	34 x 34mm	1 11/32" x 1 11/32"	8/32
18	934800 Football	Polyester		52 x 32mm	2 1/16" x 1 1/4"	8/32
19	935200 Golf	Polyester	Ø 34mm	34 x 34mm	1 11/32" x 1 11/32"	8/32
20	934700 Soccer	Polyester	Ø 34mm	34 x 34mm	1 11/32" x 1 11/32"	8/32





REF. NO.	COLOR FINISH	MATERIAL DESCRIPTION	DIMENSION C.C. / Ø	DRILL HOLE SIZE (L x W x D) METRIC	DRILL HOLE SIZE (L x W x D) IMPERIAL	SCREW NAIL
1	31007564 174	Aluminium	64mm c.c.	70 x 36 x 11mm	2 3/4" x 1 3/8" x 7/16"	M4
	31007596 174	Aluminium	96mm c.c.	102 x 36 x 11mm	4 1/8" x 1 3/8" x 7/16"	M4
	310075128 174	Aluminium	128mm c.c.	134 x 36 x 11mm	5 1/4" x 1 3/8" x 7/16"	M4
	310075160 174	Aluminium	160mm c.c.	166 x 36 x 11mm	6 1/2" x 1 3/8" x 7/16"	M4
	310075192 174	Aluminium	192mm c.c.	198 x 36 x 11mm	7 13/16" x 1 3/8" x 7/16"	M4
	310075224 174	Aluminium	224mm c.c.	230 x 36 x 11mm	9 1/16" x 1 3/8" x 7/16"	M4
	310075256 174	Aluminium	256mm c.c.	262 x 36 x 11mm	10 5/16" x 1 3/8" x 7/16"	M4
2	72260	BORB, 180, 195 Metal	Ø 60mm	55 x 15mm	2 1/8" x 9/16"	Recessed & glued
3	87076	BORB, 180, 195 Metal	76mm c.c.	85 x 25 x 12mm	3 5/16" x 1" x 7/16"	8/32
4	87096	BORB, 180, 195 Metal	96mm c.c.	107 x 30 x 12mm	4 3/16" x 1 3/16" x 7/16"	8/32
5	897128	BORB, 140, 195 Metal	128mm c.c.	134 x 28 x 13mm	5 1/4" x 1 1/8" x 1/2"	8/32

REF. NO.	COLOR FINISH	MATERIAL DESCRIPTION	DIMENSION C.C. / Ø	OVERALL DIMENSION (L x P) METRIC	OVERALL DIMENSION (L x P) IMPERIAL	SCREW NAIL
6	57680	140 Stainless Steel	80mm c.c.	100 x 38mm	3 15/16" x 1 1/2"	Wood screw
7	989880	10, 170 Aluminium	80mm c.c.	100 x 42mm	3 15/16" x 1 11/16"	Wood screw
	989850	10, 170 Aluminium	50mm c.c.	70 x 42mm	2 3/4" x 1 11/16"	Wood screw
	989833	10, 170 Aluminium	33mm c.c.	50 x 42mm	1 31/32" x 1 11/16"	Wood screw
	989825	10, 170 Aluminium	25mm c.c.	40 x 42mm	1 9/16" x 1 11/16"	Wood screw

Legend: L= Length W= Width D= Depth



REF. NO.	COLOR FINISH	MATERIAL DESCRIPTION	DIMENSION C.C. / Ø	DRILL HOLE SIZE (L x W x D) METRIC IMPERIAL		SCREW NAIL
1	900	Metal	90mm c.c.	141 x 43mm	5 9/16" x 1 11/16"	Wood screw
2	485	Metal		66 x 30 x 12mm	2 19/32" x 1 3/16" x 15/32"	Recessed
3	686	Metal		93 x 32 x 12mm	3 21/32" x 1 1/4" x 15/32"	Recessed
4	40250	Nylon		100 x 35 x 15mm	3 15/16" x 1 3/8" x 19/32"	Recessed
5	310075172	Metal	128mm c.c.	133 x 34 x 15mm	5 1/4" x 1 11/32" x 19/32"	Recessed / M4
6	386216	Metal	16mm c.c.	*40 x 47mm	*1 9/16" x 1 27/32"	Wood screw
7	39660	Metal	1" c.c.	*38 x 36mm	*1 1/2" x 1 13/32"	Wood screw
8	31007432	Metal		27 x 37 x 11mm	1 1/16" x 1 15/32" x 7/16"	Recessed / M4
9	745460	Metal/recessed handle		148 x 32 x 13mm	5 13/16" x 1 1/4" x 1/2"	Recessed
10	460370	Aluminium	50mm c.c.	*70 x 40mm	*2 3/4" x 1 9/16"	Wood screw
11	75508**	Metal	Ø 31mm	Ø 28 x 32mm	Ø 1 3/32" x 1 1/4"	Recessed

REF. NO.	COLOR FINISH	MATERIAL DESCRIPTION	DIMENSION C.C. / Ø	DRILL HOLE SIZE (L x W x D) METRIC IMPERIAL		SCREW NAIL
12	2376064	175, 195	Metal	64mm c.c.	*72 x 40mm *2 27/32" x 1 9/16"	M4
13	2376032	175, 195	Metal	32mm c.c.	*40 x 40mm *1 9/16" x 1 9/16"	M4
14	690228	130	Brass	38 x 51mm	34 x 43 x 10mm 1 11/32" x 1 11/16" x 13/32"	Wood screw
15	06320	130	Brass	75 x 50mm	57 x 38 x 5mm 2 1/4" x 1 1/2" x 3/16"	Wood screw
16	69	175	Metal	45 x 45mm	Ø 35 x 13mm 1 3/8" x 1/2"	Recessed
17	1803	130, 140	Metal	Ø 1"	Ø 20 x 7mm Ø 25/32" x 9/32"	Recessed
18	340235	195	Metal	Ø 35mm	Ø 25 x 10mm 1" x 13/32"	Recessed
19	340279	195	Metal	Ø 80mm	Ø 62 x 10mm 2 7/16" x 13/32"	Recessed
20	77370	195	Metal	2 3/4" c.c.	*80 x 35mm *3 5/32" x 1 3/8"	Wood screw
21	77325	195	Metal	1" c.c.	*36 x 37mm *1 13/32" x 1 15/32"	Wood screw
22	3110150	195	Metal	4 1/4"	119 x 30 x 13mm 4 11/16" x 1 3/16" x 1/2"	Recessed / 8/32

\* Overall dimension / non-recessed pull \*\* Push button with lock  
Legend: L = Length W = Width D = Depth





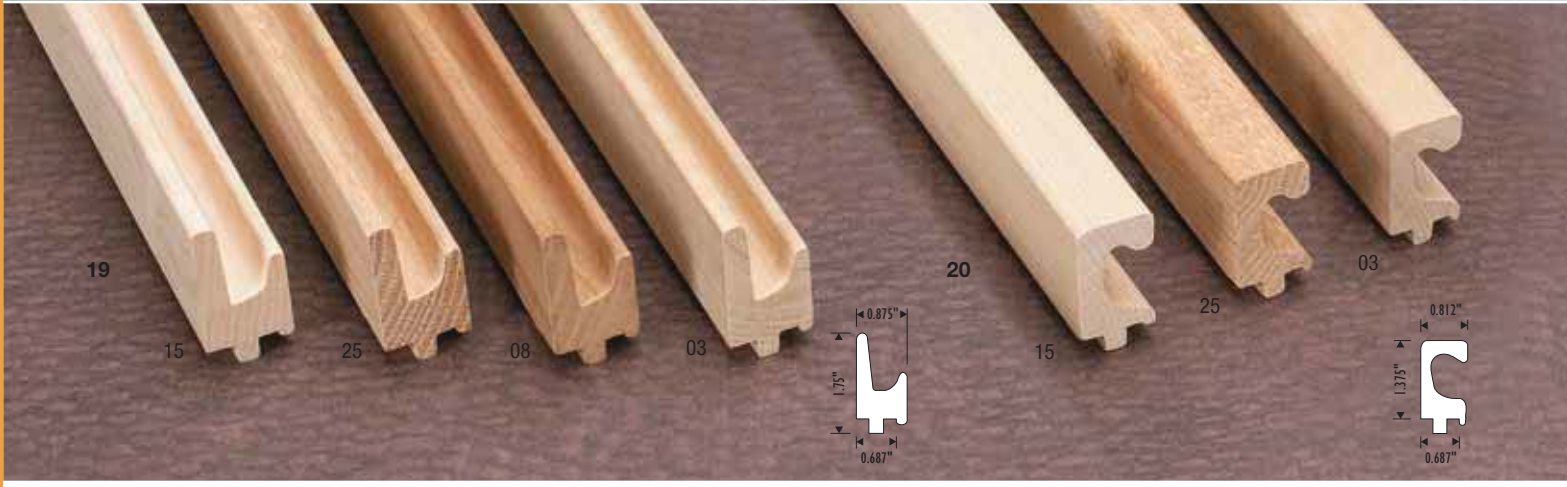

REF. NO.	COLOR FINISH	MATERIAL DESCRIPTION	DIMENSION C.C. / Ø	OVERALL DIMENSION (L x P) METRIC	OVERALL DIMENSION (L x P) IMPERIAL	SCREW NAIL
1	05403	Maple	96mm c.c.	115 x 21mm	4 17/32" x 13/16"	8/32
2	05452	Oak	96mm c.c.	107 x 27mm	4 7/32" x 1 1/16"	8/32
3	05411	Maple	96mm c.c.	115 x 25mm	4 17/32" x 1"	8/32
4	05413	Maple	3" c.c.	93 x 32mm	3 21/32" x 1 1/4"	8/32
5	115	Maple		31 x 22mm	1 7/32" x 7/8"	8/32
6	81820838	Maple	Ø 38mm	38 x 32mm	1 1/2" x 1 1/4"	8/32
7	178	Maple	Ø 1 7/8"	47 x 37mm	1 7/8" x 1 15/32"	8/32
8	138	Maple	Ø 1 3/8"	34 x 27mm	1 3/8" x 1 1/16"	8/32
9	118	Maple	Ø 1 1/8"	28 x 26mm	1 1/8" x 1 1/32"	8/32
10	02038	Maple, Oak	Ø 38mm	38 x 35mm	1 1/2" x 1 3/8"	8/32
11	7035	Oak	Ø 35mm	35 x 29mm	1 3/8" x 1 5/32"	8/32

REF. NO.	COLOR FINISH	MATERIAL DESCRIPTION	DIMENSION C.C. / Ø	OVERALL DIMENSION (L x P) METRIC	OVERALL DIMENSION (L x P) IMPERIAL	SCREW NAIL
12	114	Maple	Ø 1 1/4"	32 x 28mm	1 1/4" x 1 3/32"	8/32
13	7038	Pine	Ø 38mm	38 x 31mm	1 1/2" x 1 7/32"	8/32
14	7035	Pine	Ø 35mm	35 x 29mm	1 3/8" x 1 5/32"	8/32
15	7030	Pine	Ø 30mm	30 x 24mm	1 3/16" x 1 5/16"	8/32
16	040	Maple	Ø 40mm	40 x 32mm	1 9/16" x 1 1/4"	8/32
17	030	Maple	Ø 30mm	30 x 28mm	1 3/16" x 1 3/32"	8/32
18	05454	Oak	Ø 1 3/8"	35 x 30mm	1 3/8" x 1 3/16"	8/32
19	K243190	Birch, Cherry, Maple, Oak		2438mm	8'	
20	K243196	Birch, Maple, Oak		2438mm	8'	

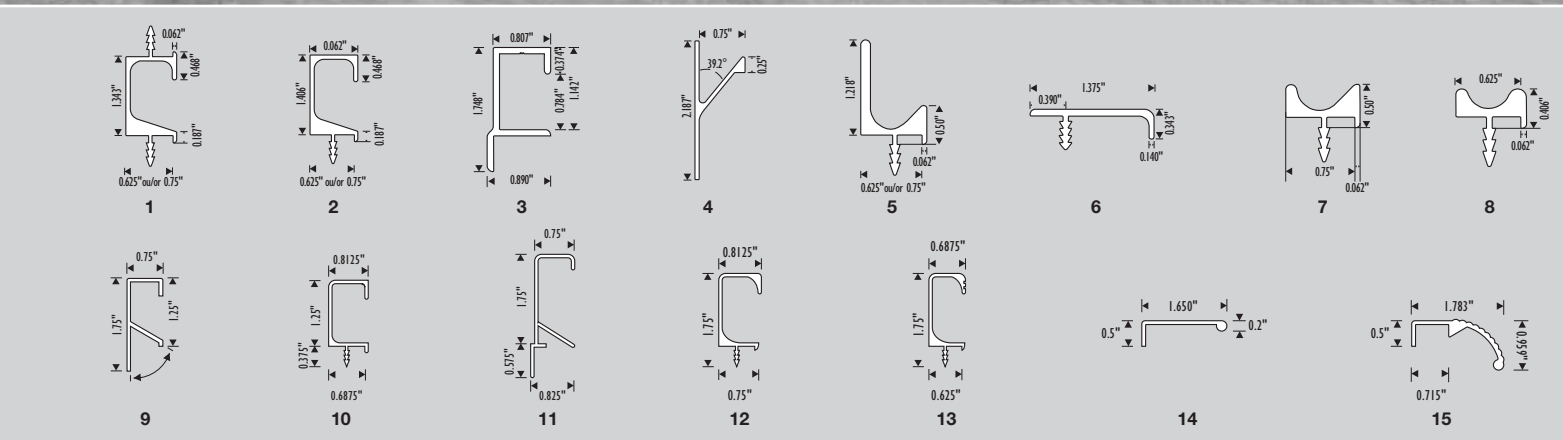
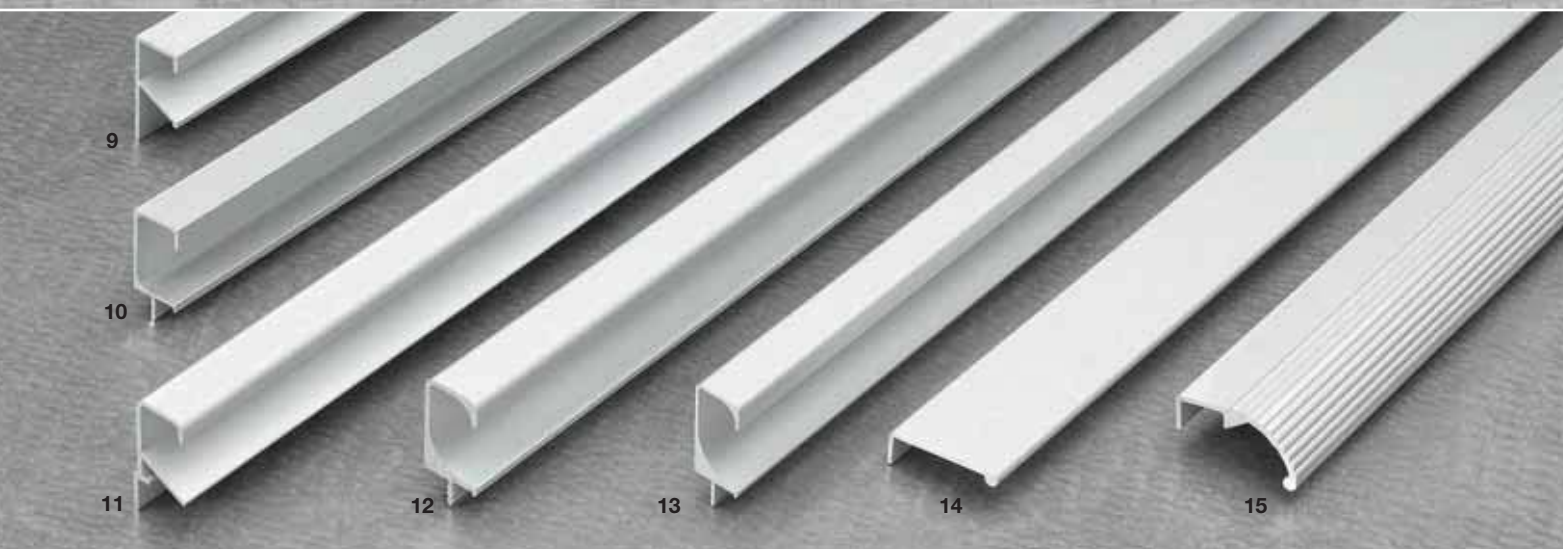

REF. NO.	COLOR FINISH	MATERIAL DESCRIPTION	PANEL THICKNESS	OVERALL DIMENSION (L)	
				METRIC	IMPERIAL
1	320112	10, 170	Aluminium	5/8" (16mm)	3657mm 12'
	320212	10, 170	Aluminium	3/4" (20mm)	3657mm 12'
2	320012	10, 170	Aluminium	5/8" (16mm)	3657mm 12'
	319912	10, 170	Aluminium	3/4" (20mm)	3657mm 12'
3	415212	10	Aluminium	3/4" (20mm) to 13/16" (21mm)	3657mm 12'
4	314912	10	Aluminium	3/4" (20mm)	3657mm 12'
5	318812	10, 140, 170	Aluminium	5/8" (16mm)	3657mm 12'
	318912	10, 140, 170	Aluminium	3/4" (20mm)	3657mm 12'
6	329112	10, 140, 170	Aluminium	3/4" (20mm)	3657mm 12'

REF. NO.	COLOR FINISH	MATERIAL DESCRIPTION	PANEL THICKNESS	OVERALL DIMENSION (L)	
				METRIC	IMPERIAL
7	318712	10, 140, 170	Aluminium	3/4" (20mm)	3657mm 12'
8	329012	10, 140, 170	Aluminium	5/8" (16mm)	3657mm 12'
9	318112	10	Aluminium	5/8" (16mm)	3657mm 12'
10	318212	10	Aluminium	5/8" (16mm)	3657mm 12'
11	317912	10	Aluminium	3/4" (20mm)	3657mm 12'
12	318312	10, 140	Aluminium	3/4" (20mm)	3657mm 12'
13	318412	10	Aluminium	5/8" (16mm)	3657mm 12'
14	318612	10, 170	Aluminium	5/8" (16mm) to 3/4" (20mm)	3657mm 12'
15	318512	10	Aluminium	5/8" (16mm)	3657mm 12'



# HOOKS CONTEMPORARY





11



12



13

Mirror



16



14



15

Mirror

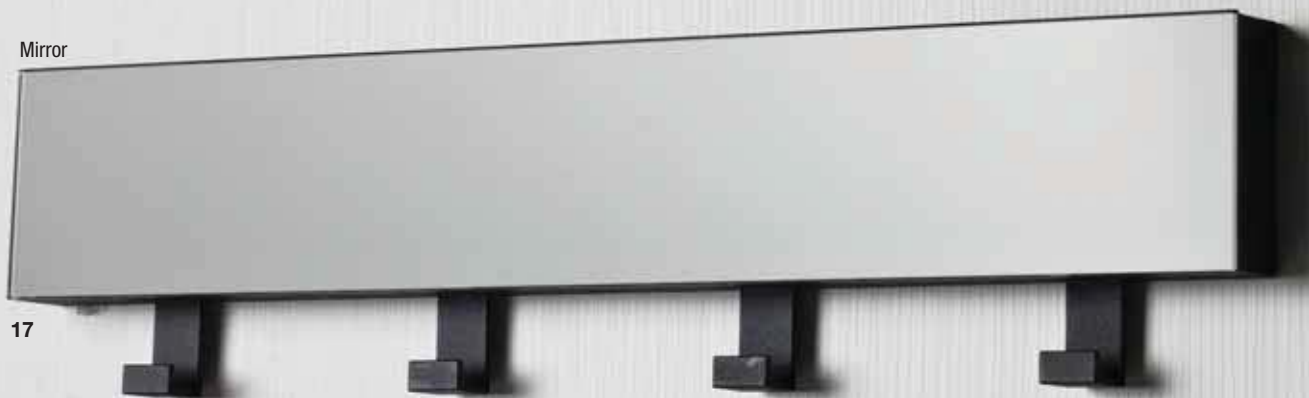

17

REF. NO.	COLOR FINISH	MATERIAL DESCRIPTION	DIMENSION C.C. / Ø	OVERALL DIMENSIONS (H x L/W x P) METRIC	OVERALL DIMENSIONS (H x L/W x P) IMPERIAL	SCREW NAIL	
1	56117	184	Metal	230 x 70 x 95mm	9 1/16" x 2 3/4" x 3 3/4"	Anchor incl.	
2	56120	195	Metal	86 x 97 x 83mm	3 3/8" x 3 13/16" x 3 1/4"	Anchor incl.	
3	512310	140	Metal	144 x 50 x 110mm	5 21/32" x 1 31/32" x 4 11/32"	Anchor incl.	
4	56125	174	Metal	118 x 120 x 82mm	4 5/8" x 4 11/16" x 3 3/16"	Anchor incl.	
5	254120	140	Metal	16mm c.c.	101 x 75 x 45mm	4" x 2 15/16" x 1 3/4"	Anchor incl.
6	330105	01/140	Metal & crystal	100 x 40 x 65mm	3 15/16" x 1 9/16" x 2 9/16"	Anchor incl.	
7	330105	11/140	Metal & Murano glass	100 x 40 x 55mm	3 15/16" x 1 9/16" x 2 1/8"	Anchor incl.	
8	56116	174, 195	Metal	175 x 100 x 44mm	6 7/8" x 3 15/16" x 1 23/32"	Anchor incl.	
9	56115	195	Metal	185 x 65 x 92mm	7 9/32" x 2 9/16" x 3 5/8"	Anchor incl.	
10	284060	180	Metal	60 x 60 x 40mm	2 3/8" x 2 3/8" x 1 9/16"	Anchor incl.	

REF. NO.	COLOR FINISH	MATERIAL DESCRIPTION	DIMENSION C.C. / Ø	OVERALL DIMENSIONS (H x L/W x P) METRIC	OVERALL DIMENSIONS (H x L/W x P) IMPERIAL	SCREW NAIL	
11	*10870	30	Plastic & LED light	23mm c.c.	88 x 84 x 46mm	3 7/16" x 3 1/4" x 1 13/16"	Wood screw
12	*1087	906	Plastic & LED light	23mm c.c.	88 x 84 x 46mm	3 7/16" x 3 1/4" x 1 13/16"	Wood screw
13	*10860	30	Plastic & LED light	64mm c.c.	176 x 31 x 46mm	6 7/8" x 1 3/16" x 1 13/16"	Wood screw
14	73023	195	Aluminium	194mm c.c.	22 x 215 x 40mm	7/8" x 8 7/16" x 1 9/16"	Wood screw
15	73025	195	Aluminium	354mm c.c.	22 x 375 x 40mm	7/8" x 14 3/4" x 1 9/16"	Wood screw
16	**28356	910	Acrylic & mirror	89mm c.c.	142 x 150 x 38mm	5 9/16" x 5 7/8" x 1 1/2"	Wood screw
17	**283512	910	Acrylic & mirror	539mm c.c.	142 x 600 x 38mm	5 9/16" x 24" x 1 1/2"	Wood screw

\* Rechargeable lighted hook with motion sensor (micro USB cable included)

\*\* Retractable hook





REF. NO.	COLOR FINISH	MATERIAL DESCRIPTION	OVERALL DIMENSION (H x L/W x P) METRIC IMPERIAL	SCREW NAIL
1	T11560 30, 90	Metal	190 x 77 x 54mm 7 15/32" x 3 1/32" x 2 1/8"	Screw incl.
2	BP6513 30, 90, 130, 140, 184	Metal	120 x 25 x 89mm 4 23/32" x 1" x 3 1/2"	Screw incl.
3	BP6514 30, 90, 130, 140, 184	Metal	85 x 21 x 64mm 3 11/32" x 13/16" x 2 17/32"	Screw incl.
4	BP6506 30, 90, 130, 140, 184	Metal	45 x 22 x 38mm 1 25/32" x 7/8" x 1 1/2"	Screw incl.
5	BP6508 30, 90, 130, 140, 184	Metal	38 x 77 x 28mm 1 1/2" x 3 1/32" x 1 3/32"	Screw incl.
6	T5630 30, 130, 140, 184	Metal	85 x 20 x 44mm 3 11/32" x 25/32" x 1 23/32"	Screw incl.
7	60434 145	Aluminium	118 x 12 x 92mm 4 21/32" x 15/32" x 3 5/8"	Wood screw

REF. NO.	COLOR FINISH	MATERIAL DESCRIPTION	OVERALL DIMENSION (H x L/W x P) METRIC IMPERIAL	SCREW NAIL
8	6215 140	Metal	35 x 8 x 55mm 1 3/8" x 5/16" x 2 5/32"	Screw incl.
9	40000 140	Stainless steel	58 x 37 x 77mm 2 9/32" x 1 15/32" x 3 1/32"	Wood screw
10	T5610 184	Brass	75 x 220 x 25mm 2 15/16" x 8 21/32" x 1"	Screw incl.
11	T5619 30	Metal	45 x 144 x 44mm 1 25/32" x 5 21/32" x 1 23/32"	Screw incl.
12	T5620 30	Metal	45 x 232 x 44mm 1 25/32" x 9 1/8" x 1 23/32"	Screw incl.
13	T5621 30	Metal	45 x 319 x 44mm 1 25/32" x 12 9/16" x 1 23/32"	Screw incl.
14	T5622 30	Metal	45 x 498 x 44mm 1 25/32" x 19 19/32" x 1 23/32"	Screw incl.



REF. NO.	COLOR FINISH	MATERIAL DESCRIPTION	OVERALL DIMENSIONS (H x L/W x P) METRIC IMPERIAL	SCREW NAIL
1	T5628 140, 184	Metal	200 x 74 x 80mm 7 7/8" x 2 29/32" x 3 5/32"	Screw incl.
2	T5629 140, 184	Metal	65 x 40 x 33mm 2 9/16" x 1 9/16" x 1 5/16"	Screw incl.
3	849120 140, 195	Metal	126 x 16 x 52mm 5" x 5/8" x 2"	8/32
4	84965 140, 195	Metal	61 x 16 x 52mm 2 3/8" x 5/8" x 2"	8/32
5	56118 140	Metal	130 x 120 x 53mm 5 1/8" x 4 23/32" x 2 3/32"	Wood screw
6	T5612 130, 140, 184	Metal	80 x 180 x 109mm 3 5/32" x 7 3/32" x 4 9/32"	Screw incl.
7	560003 170	Stainless steel	88 x 20 x 80mm 3 15/32" x 25/32" x 3 5/32"	Anchor incl.
8	560002 170	Stainless steel	175 x 20 x 100mm 6 7/8" x 25/32" x 3 15/16"	Anchor incl.
9	51128 170	Stainless steel	∅ 20 x 60mm 25/32" x 2 3/8"	Anchor incl.
10	51127 170	Stainless steel	∅ 16 x 35mm 5/8" x 1 3/8"	Anchor incl.
11	51122 170	Stainless steel	∅ 45 x 47mm 1 25/32" x 1 27/32"	Anchor incl.
12	51124 170	Stainless steel	∅ 25 x 30mm ∅ 1" x 1 3/16"	Anchor incl.

REF. NO.	COLOR FINISH	MATERIAL DESCRIPTION	OVERALL DIMENSIONS (H x L/W x P) METRIC IMPERIAL	SCREW NAIL
13	BP7001 10	Aluminium	40 x 20 x 40mm 1 9/16" x 25/32" x 1 9/16"	Wood screw
14	BP7002 10	Aluminium	20 x 216 x 40mm 25/32" x 8 1/2" x 1 9/16"	Wood screw
15	75250 170	Stainless steel	62 x 27 x 250mm 2 5/8" x 1 1/16" x 9 27/32"	Wood screw
16	75710 171	Stainless steel	39 x 35 x 36mm 1 17/32" x 1 3/8" x 1 13/32"	Wood screw
17	75701 171	Stainless steel	16 x 11mm 5/8" x 7/16"	
	75702 171	Stainless steel	19 x 13mm 3/4" x 1/2"	
	75703 171	Stainless steel	22 x 15mm 7/8" x 19/32"	
	75705 171	Stainless steel	30 x 20mm 1 3/16" x 25/32"	
18	75706 171	Stainless steel	18 x 11mm 23/32" x 7/16"	
	75707 171	Stainless steel	26 x 15mm 1 1/32" x 19/32"	
	75708 171	Stainless steel	34 x 20mm 1 11/32" x 25/32"	
19	75715 170	Stainless steel	54 x 43 x 26mm 2 1/8" x 1 11/16" x 1 1/32"	Wood screw

# HOOKS TRADITIONAL



REF. NO.	COLOR FINISH	MATERIAL DESCRIPTION	OVERALL DIMENSIONS (H x L/W x P) IMPERIAL	SCREW NAIL
1	800, 900, 908	Forged iron	250 x 70 x 105mm 9 27/32" x 2 3/4" x 4 1/8"	Wood screw
2	800, 900, 908	Forged iron	105 x 70 x 98mm 4 1/8" x 2 3/4" x 3 27/32"	Wood screw
3	800, 900	Forged iron	63 x 30 x 30mm 2 15/32" x 1 3/16" x 1 3/16"	Wood screw
4	BORB, 140, 195	Metal	38 x 45 x 34mm 1 1/2" x 1 25/32" x 1 5/16"	Wood screw
5	AE, BORB, 195	Metal	155 x 68 x 79mm 6 1/16" x 2 5/8" x 3 1/8"	Wood screw
6	AE, BORB, 195	Metal	76 x 68 x 45mm 3" x 2 5/8" x 1 3/4"	Wood screw
7	T5605	Iron	140 x 45 x 80mm 5 1/2" x 1 25/32" x 3 5/32"	Screw incl.

REF. NO.	COLOR FINISH	MATERIAL DESCRIPTION	OVERALL DIMENSIONS (H x L/W x P) IMPERIAL	SCREW NAIL
8	T5618	Iron	140 x 32 x 86mm 5 1/2" x 1 1/4" x 3 3/8"	Screw incl.
9	T5604	Iron	102 x 35 x 67mm 4 1/32" x 1 3/8" x 2 5/8"	Screw incl.
10	T5611	130, 140, 184, 900	Metal 120 x 71 x 40mm 4 23/32" x 2 25/32" x 1 9/16"	Screw incl.
11	T5606	900	Iron 59 x 23 x 105mm 2 5/16" x 29/32" x 4 1/8"	Screw incl.
12	43160	163, 904	Brass 109 x 75 x 68mm 4 9/32" x 2 15/16" x 2 11/16"	Wood screw
13	43113	163, 904	Brass 113 x 57 x 85mm 4 7/16" x 2 1/4" x 3 11/32"	Wood screw



REF. NO.	COLOR FINISH	MATERIAL DESCRIPTION	C.C. / Ø DIMENSION	OVERALL DIMENSION (L x H) METRIC	OVERALL DIMENSION (L x H) IMPERIAL
1	1040 AE, BORB, 143, 180, 195	Metal plate	64 x 32mm	2 5/8" x 1 1/4"	
2	104096 AE, BORB, 143, 180, 195	Metal plate	96mm c.c.	156 x 32mm	6 1/8" x 1 1/4"
3	1040128 AE, BORB, 143, 180, 195	Metal plate	128mm c.c.	188 x 32mm	7 3/8" x 1 1/4"
4	1045 AE, BORB, 143, 180, 195	Metal plate	64 x 32mm	2 5/8" x 1 1/4"	

REF. NO.	COLOR FINISH	MATERIAL DESCRIPTION	C.C. / Ø DIMENSION	OVERALL DIMENSION (L x H/P) METRIC	OVERALL DIMENSION (L x H/P) IMPERIAL
5	104596 AE, BORB, 143, 180, 195	Metal plate	96mm c.c.	156 x 32mm	6 1/8" x 1 1/4"
6	1045128 AE, BORB, 143, 180, 195	Metal plate	128mm c.c.	188 x 32mm	7 3/8" x 1 1/4"
7	1038 BB, 130, 140	Metal plate	3" c.c.	145 x 24mm	5 23/32" x 15/16"
8	464 AE, A91, 130, 140, 142, 195	Metal plate	Ø 52mm	52 x 9mm	2 1/16" x 11/32"





REF. NO.	COLOR FINISH	MATERIAL DESCRIPTION	OVERALL DIMENSION (L x H) METRIC	OVERALL DIMENSION (L x H) IMPERIAL	HOLE DIMENSION
1	705310 AE, BORB, 180, 195	Solid brass	285mm x 109mm	11 7/32" x 4 19/64"	3" x 10"
	705410* AE, BORB, 180, 195	Solid brass	281mm x 127mm	11 1/16" x 5"	4" x 10"

REF. NO.	COLOR FINISH	MATERIAL DESCRIPTION	OVERALL DIMENSION (L x H) METRIC	OVERALL DIMENSION (L x H) IMPERIAL	HOLE DIMENSION
2	704310 AE, BORB, 180, 195	Solid brass	283mm x 107mm	11 9/64" x 4 7/32"	3" x 10"
	704410* AE, BORB, 180, 195	Solid brass	278mm x 130mm	10 15/16" x 5 1/8"	4" x 10"

\* = Hole dimension : 4" x 10"





REF. NO.	COLOR FINISH	MATERIAL DESCRIPTION	OVERALL DIMENSION (L x H)		HOLE DIMENSION
			METRIC	IMPERIAL	
1	712310 CB, DB, PB	Solid bronze	284mm x 110mm	11 3/16" x 4 21/64"	3" x 10"
	712410* CB, DB, PB	Solid bronze	280mm x 125mm	11 1/32" x 4 59/64"	4" x 10"

REF. NO.	COLOR FINISH	MATERIAL DESCRIPTION	OVERALL DIMENSION (L x H)		HOLE DIMENSION
			METRIC	IMPERIAL	
2	709310 AE, BORB, 180, 195	Solid brass	277mm x 106mm	10 29/32" x 4 11/64"	3" x 10"
	709410* AE, BORB, 180, 195	Solid bronze	282mm x 131mm	11 7/64" x 5 5/32"	4" x 10"

\* = Hole dimension : 4" x 10"



REF. NO.	COLOR FINISH	MATERIAL DESCRIPTION	OVERALL DIMENSION (L/W x H)		THICKNESS		SCREW
			METRIC	IMPERIAL	METRIC	IMPERIAL	
1	8522 AE, BORB, 195	Metal	123mm x 123mm	4 27/32" x 4 27/32"	6.5mm	1/4"	incl.
2	852 AE, BORB, 195	Metal	77mm x 126mm	3 1/32" x 4 61/64"	6.5mm	1/4"	incl.
3	8533 AE, BORB, 195	Metal	123mm x 123mm	4 27/32" x 4 27/32"	6.5mm	1/4"	incl.
4	853 AE, BORB, 195	Metal	77mm x 126mm	3 1/32" x 4 61/64"	6.5mm	1/4"	incl.
5	85333 AE, BORB, 195	Metal	172mm x 123mm	6 3/4" x 4 53/64"	6.5mm	1/4"	incl.

REF. NO.	COLOR FINISH	MATERIAL DESCRIPTION	OVERALL DIMENSION (L/W x H)		THICKNESS		SCREW
			METRIC	IMPERIAL	METRIC	IMPERIAL	
6	851 AE, BORB, 195	Metal	77mm x 125mm	3 1/32" x 4 59/64"	6.5mm	1/4"	incl.
7	8511 AE, BORB, 195	Metal	123mm x 123mm	4 13/16" x 4 13/16"	6.5mm	1/4"	incl.
8	85111 AE, BORB, 195	Metal	172mm x 123mm	6 49/64" x 4 27/32"	6.5mm	1/4"	incl.
9	851111 AE, BORB, 195	Metal	217mm x 123mm	8 35/64" x 4 27/32"	6.5mm	1/4"	incl.



REF. NO.	COLOR FINISH	MATERIAL DESCRIPTION	OVERALL DIMENSION (L/W x H) METRIC IMPERIAL	THICKNESS METRIC IMPERIAL	SCREW
1	8622 AE, BORB, 195	Metal	123mm x123mm 4 27/32" x 4 27/32"	6.5mm 1/4"	incl.
2	862 AE, BORB, 195	Metal	77mm x 126mm 3 1/32" x 4 61/64"	6.5mm 1/4"	incl.
3	8633 AE, BORB, 195	Metal	123mm x 123mm 4 27/32" x 4 27/32"	6.5mm 1/4"	incl.
4	863 AE, BORB, 195	Metal	77mm x 126mm 3 1/32" x 4 61/64"	6.5mm 1/4"	incl.
5	86333 AE, BORB, 195	Metal	172mm x 123mm 6 3/4" x 4 53/64"	6.5mm 1/4"	incl.

REF. NO.	COLOR FINISH	MATERIAL DESCRIPTION	OVERALL DIMENSION (L/W x H) METRIC IMPERIAL	THICKNESS METRIC IMPERIAL	SCREW
6	861 AE, BORB, 195	Metal	77mm x 125mm 3 1/32" x 4 59/64"	6.5mm 1/4"	incl.
7	8611 AE, BORB, 195	Metal	123mm x 123mm 4 13/16" x 4 13/16"	6.5mm 1/4"	incl.
8	86111 AE, BORB, 195	Metal	172mm x 123mm 6 49/64" x 4 27/32"	6.5mm 1/4"	incl.
9	861111 AE, BORB, 195	Metal	217mm x 123mm 8 35/64" x 4 27/32"	6.5mm 1/4"	incl.

# WIRE MESH

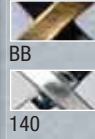

1

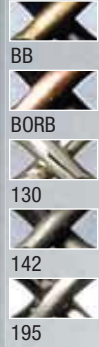

2

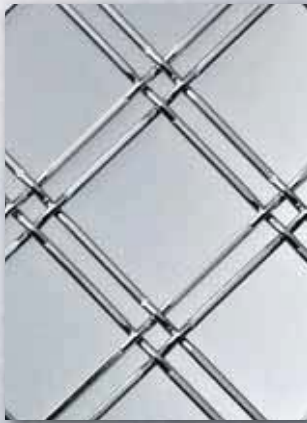

3

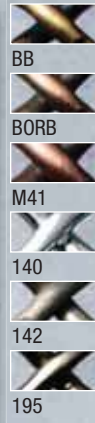

4

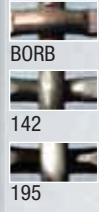
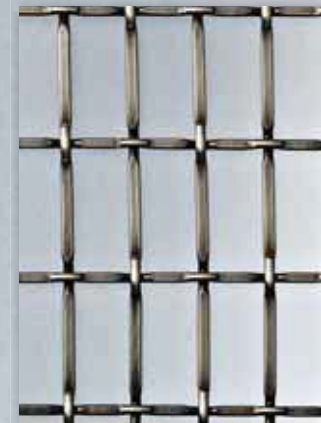

5



6



7

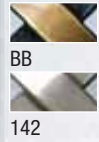

8

REF. NO.	COLOR FINISH	MATERIAL DESCRIPTION	OVERALL DIMENSIONS (W x H) IMPERIAL
1	88316 BB, 140	Metal	36" x 48"
2	88122024 BB	Metal	24" x 72"
	833234 BORB, 195	Metal	36" x 48"
	881220 BB, 130, 142	Metal	36" x 48"
	833246 BORB, 142, 195	Metal	48" x 72"
	88122048 BB	Metal	48" x 72"
3	88114 BB, 140	Metal	36" x 48"

REF. NO.	COLOR FINISH	MATERIAL DESCRIPTION	OVERALL DIMENSIONS (W x H) IMPERIAL
4	881214 BB, M41, 140, 142	Metal	36" x 48"
	8121434 195	Metal	36" x 48"
	8121446 BB, BORB, 142, 195	Metal	48" x 72"
5	881134 BORB, 142, 195	Metal	36" x 48"
6	881215 BB	Metal	24" x 72"
7	88332 BB	Metal	36" x 48"
8	88286 BB, 142	Metal	36" x 48"